

Thank you for choosing Sunnydaze Decor. We stand behind our brand and the quality of the items we sell. Replacement parts or products will be sent at our discretion within the 1-year warranty period. Proof of purchase, with the date of purchase as well as photos of the merchandise defect, must be provided. Photos are used to determine the cause of defects and for future quality control. Register your warranty at <https://tiny.cc/SunnydazeWarranty>. If you have any questions, comments or concerns, feel free to contact us by phone at 833-982-1977, by email: customerservice@sunnydazedecor.com, or via our contact us page at <https://tiny.cc/SunnydazeContact>

TUFTED CUSHION PATIO SWING LR-243

Read all assembly and care instructions carefully before using this product. Save this document for future reference.
Assemble components on a soft, clean surface to avoid scratching or damaging the finish.

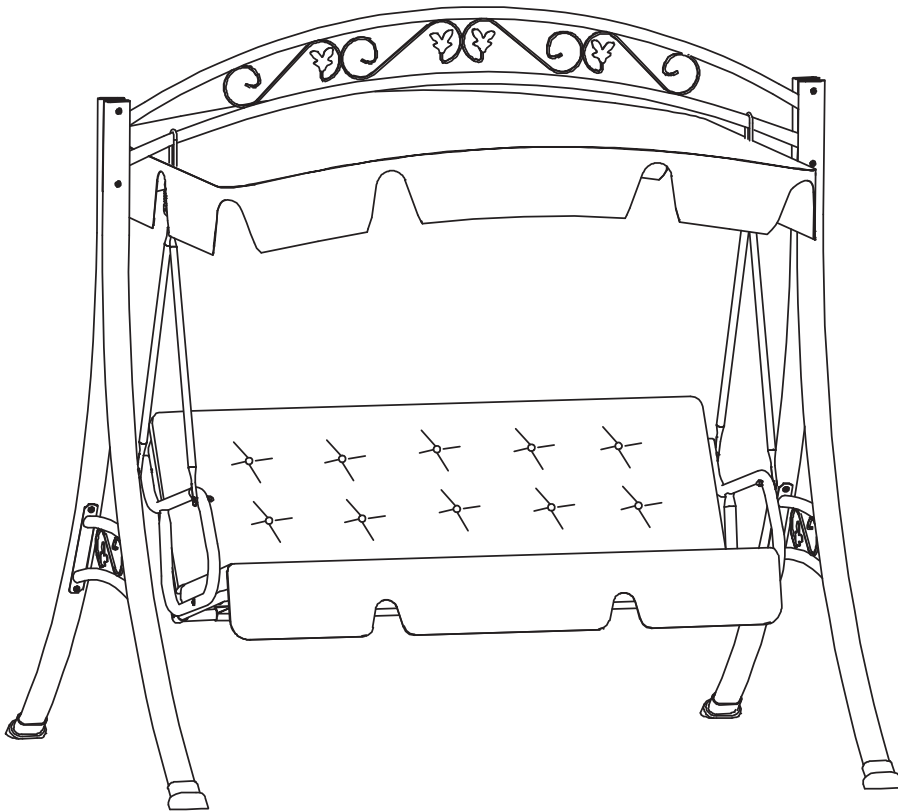

Inspect packaging to ensure all parts are accounted for before disposing of packing materials.

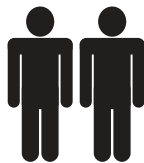



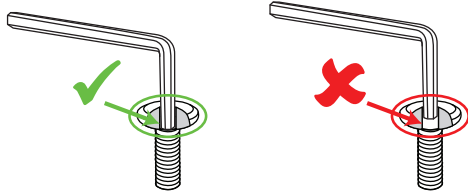



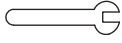

















2-PERSON
ASSEMBLY



Tip: Always fully insert the hex key inside designated notch of the bolt to prevent the bolt head from stripping.

INCLUDED TOOLS	
	Hex Keys
	Spanner

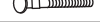
No.	PARTS	QTY.
A	 Leg	4
B	 Top Bar	1
C	 Canopy Center Bar	1
D	 Swing Frame	4
E	 Frame Side Support	2
F	 Seat Arm	2
G	 Extension Spring	2
H	 Seat	1
I	 Canopy End Frame	2
J	 Canopy Side Bar	2
K	 Canopy Fabric	1
L	 Knob	2
M	 Spacer	2
V	 Seat Cushion	1
W	 Back Cushion	1

No.	HARDWARE	QTY.
N	 M6 x 40mm Bolt	2
O	 M8 x 20mm Bolt	8
P	 M8 x 45mm Bolt	2
Q	 M8 x 75mm Bolt	2
R	 M8 x 95mm Bolt	4
S	 Washer	18
T	 Lock Nut	10
U	 Nut Cap	10
X	 M8 x 50mm Bolt	2
Y	 M8 x 68mm Bolt	2

⚠ WARNING ⚠

CHOKING HAZARD — This item contains small parts that can be swallowed by children. Keep children away during assembly.

ASSEMBLY

Understand assembly completely before beginning.

Tip: Always fully insert the hex key inside designated notch of the bolt to prevent the bolt head from stripping.

STEP 1 **NOTE:**

- A: 4
- B: 1
- R: 4
- S: 4
- T: 4
- U: 4

When installing lock nuts, the metal thread goes on first. Hand-tighten until you feel resistance, which is caused by the nylon insert.

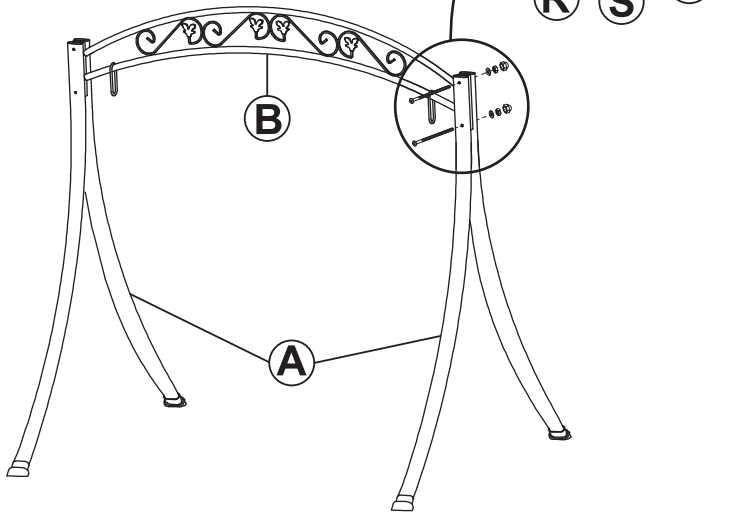

Do not fully tighten hardware until step 2 is completed.

STEP 2

- E: 2
- O: 8
- S: 8

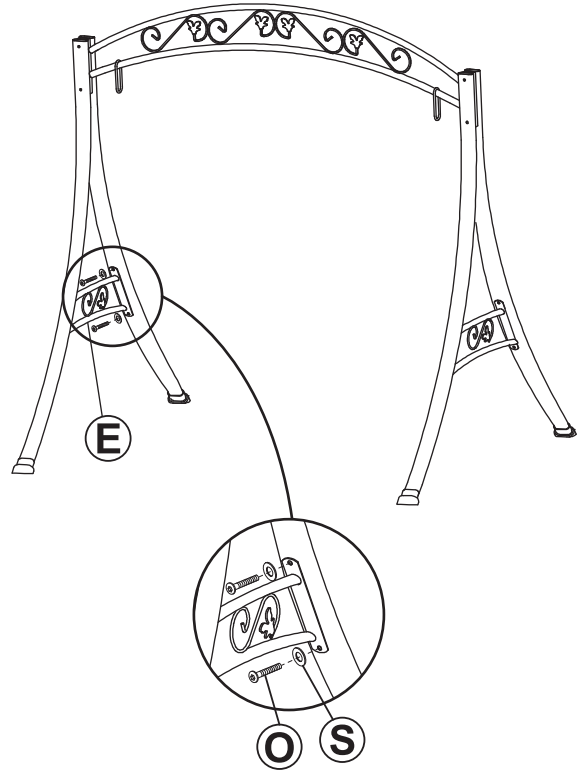

STEP 3

- D: 4
- F: 2
- H: 1
- P: 2
- Q: 2
- S: 6
- T: 6
- U: 6
- Y: 2

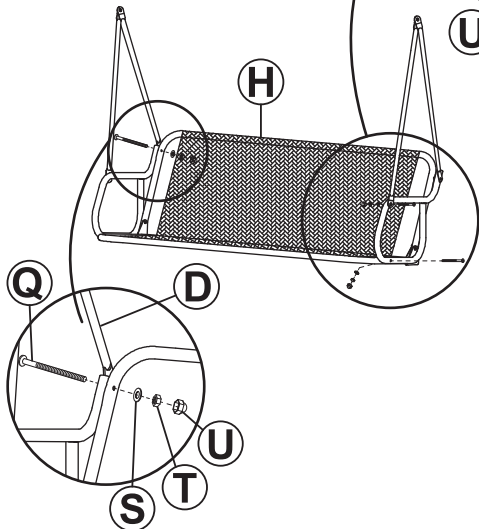
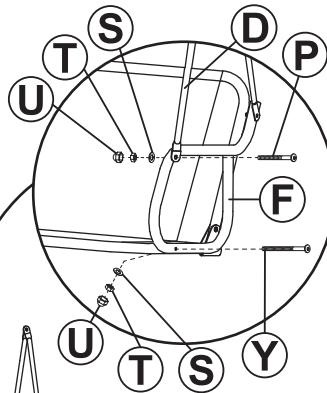

STEP 4

- I: 1
- J: 2
- K: 1

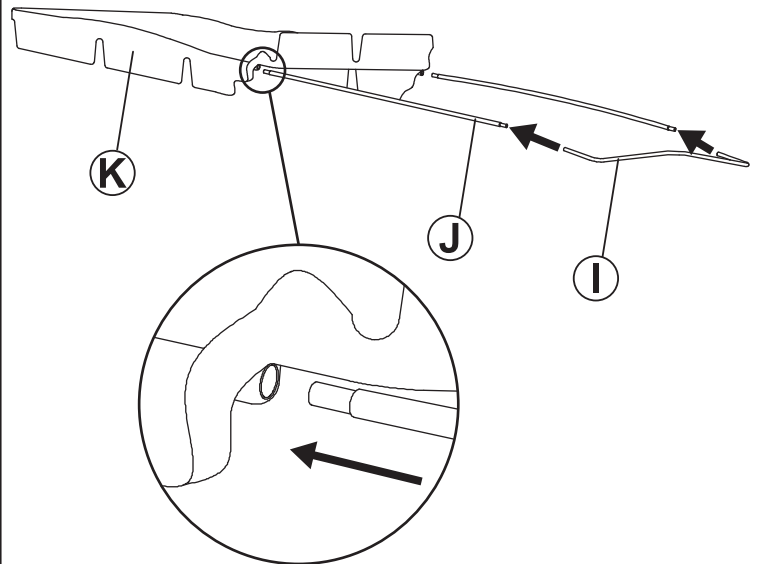

STEP 5

C: 1
I: 1
N: 2

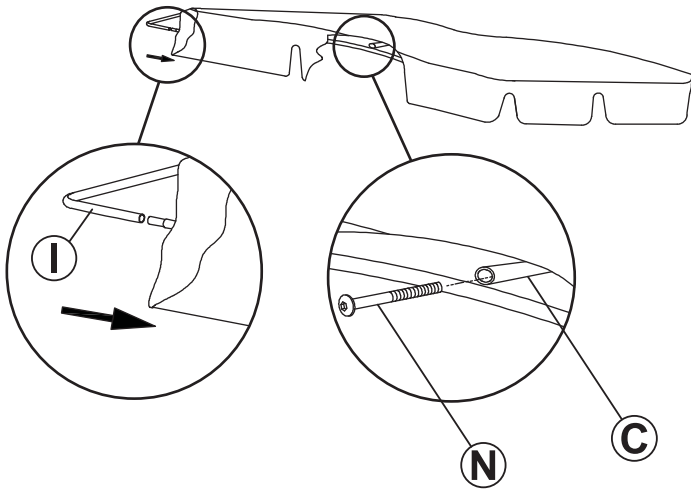

STEP 6

L: 2
M: 2
X: 2

Snap Spacer (M) to the inside of the oval ring that is welded to the Top Bar (B) before installing the canopy.

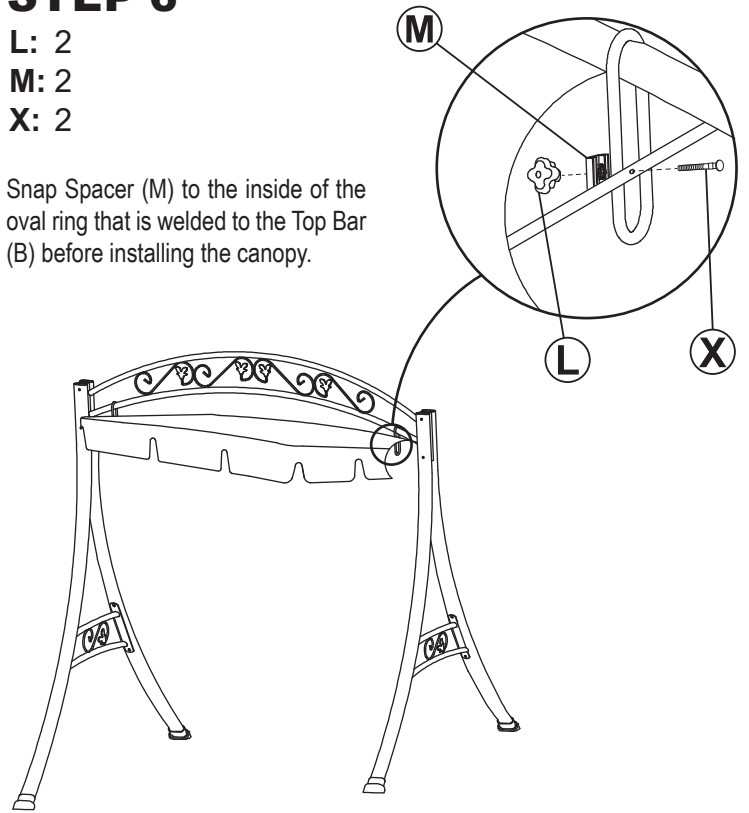

STEP 7

G: 2

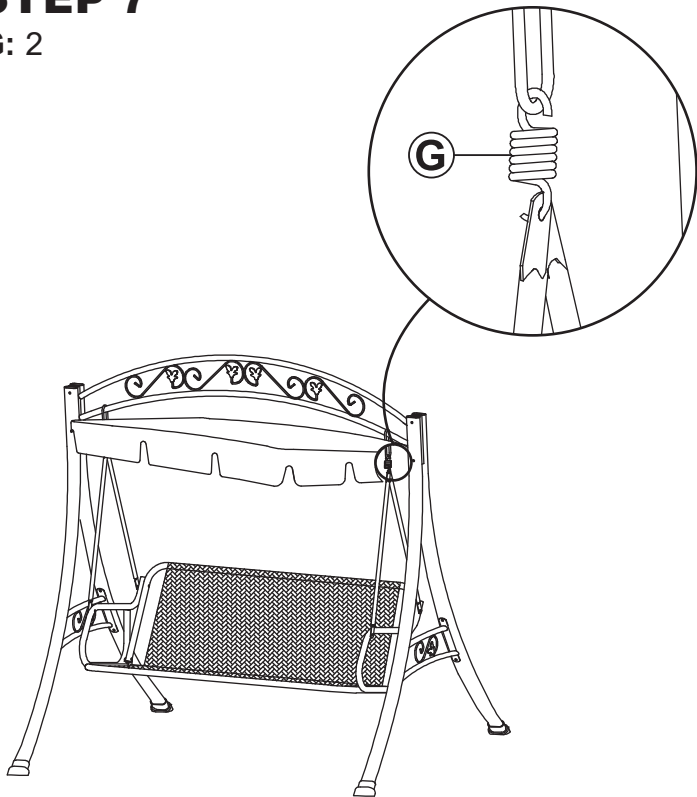

STEP 8

V: 1
W: 1

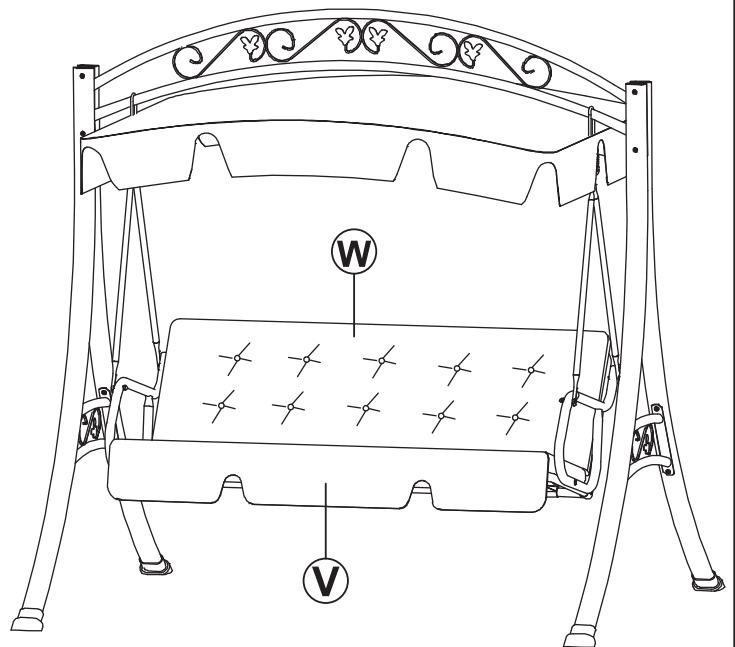

! HELPFUL HINT

Inspect all assembly points to ensure all hardware is securely fastened before using the swing.

USE & CARE

SAFE USE: Bouncing, jumping and other excessive movement while using the patio swing may cause serious injury including, but not limited to, the swing tipping over.

INSPECTION: Ensure the unit is assembled correctly and all hardware is securely fastened.

SWINGING: While in a seated position with feet in contact with the ground, gently move the swing in a front-to-back direction.

CHILDREN: Supervise children at all times. Do not allow children to play or sleep on the swing.

EXPOSURE: Over time, sunlight and weather elements will degrade and change the color of cushions and the finish on the frame. Maintain cushion color and integrity by storing them indoors when not in use. Covering the porch swing with a breathable outdoor furniture cover while not in use will help protect it from the elements. Cover not included.

STORAGE: Store the cushions and canopy indoors when not in use. Cool, dry locations are recommended to prevent damage that may result from exposure to moisture. Covering furniture while in storage is recommended to help prevent dust build-up. Always ensure all fabrics are completely dry before storage.

SCRATCHES: The powder coating on the frame is tough and durable but, even with normal use, some scratching is inevitable. To avoid excessive rust, wipe scratched areas with a soft cloth to remove moisture.

CLEANING

Do not use harsh chemicals or abrasive materials to clean the furniture.

 HAND-WASH ONLY

 DO NOT USE BLEACH

 DO NOT USE A PRESSURE WASHER

Cushions/Canopy

- Brush or vacuum loose dirt from the cushions/canopy.
- Wipe down using a soft cloth and warm water.

Swing Frame

- Remove all cushions and canopy.
- Brush, vacuum or use a garden hose to remove loose dirt and debris. If using a hose with a spray nozzle, use gentle or medium pressure settings; using high-pressure sprayer may damage the construction and finish of the frame, and void the product warranty.
- Dry using a soft, lint-free cloth.

SAFETY STATEMENTS & WARNINGS

- Do not exceed the weight capacity of the furniture.
- Do not stand on any part of this item.
- Use care when getting in and out of the swing.
- Keep feet in contact with the ground while swinging. Excessive swinging movement can cause the swing to tip over.
- Remove and store the canopy during windy conditions to prevent uplift and/or tipping.
- Inspect the swing and frame to ensure all hardware is fully tightened before each use.
- Do not allow children to use this product without adult supervision.

WARNING: THE ONE-YEAR WARRANTY DOES NOT COVER DAMAGES OR DEFECTS CAUSED BY THE APPLICATION OF CHEMICAL TREATMENTS OR PROTECTIVE COATINGS.

Any modification to the product or failure to follow recommended care will void the product warranty.

WARNING

Manufacturer and seller expressly disclaim any and all liability from personal injury, property damage or loss, whether direct or indirect, or incidental, resulting from the incorrect attachment, improper use, inadequate maintenance, or neglect of this product.