

INSTALLATION INSTRUCTIONS

SNAP-OFF TOILET SEAT

American Standard

Style That Works Better

Elongated Models: 5280.510, 5321.110, 5350.510, 5361.110, 5363.110, 5352.110

Round Front Models: 5285.510, 5320.110, 5345.510, 5364.110, 5365.110, 5351.110

Thank you for selecting American Standard – the benchmark of fine quality for over 100 years. To ensure this product is installed properly, please read these instructions carefully before you begin. (Certain installations may require professional help.) Also be sure your installation conforms to local codes.

NOTE: Pictures may not exactly depict toilet seat and components.

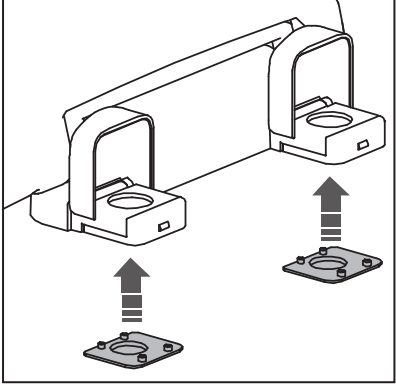
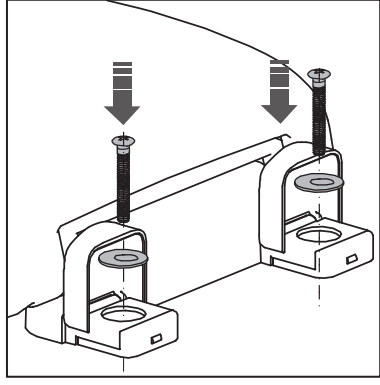
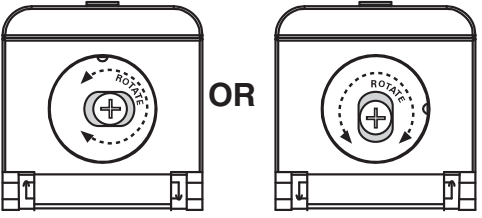
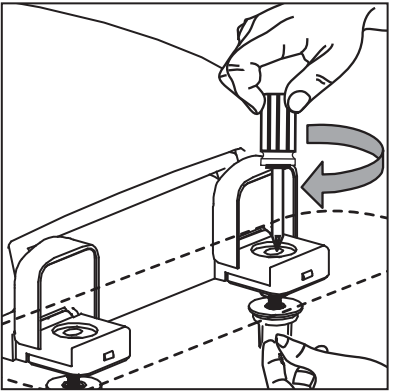
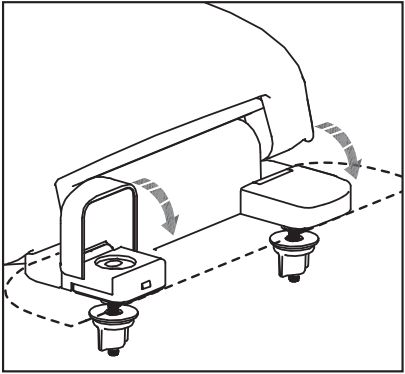
| | | |
|---|---|---|
| <p>1</p>  <p>Install rubber base to seat post hinges.</p> | <p>2</p>  <p>Slip the bolts through the washers, then through the hinge holes.</p> | <p>3</p> <p style="text-align: center;">TANK</p>  <p style="text-align: center;">OR</p> <p style="text-align: center;">FRONT OF BOWL</p> <p>The hinge features built-in adjustable washers. Rotate washers as needed for the best alignment of the seat on the toilet bowl.</p> |
| <p>4</p>  <p>Thread the nuts onto the bolts. Tighten the bolts using a screwdriver. DO NOT OVERTIGHTEN.</p> | <p>5</p>  <p>Close the hinge covers. The seat will not work if the hinge covers are not closed tightly.</p> | <p>Care and Cleaning</p> <p>When cleaning your toilet seat wash it with a mild, soapy water: rinse the seat thoroughly with clear water and dry with a soft cloth.</p> <p>Avoid detergents, disinfectants, or cleaning products in aerosol cans. Never use abrasive scouring powders on your seat. Some bathroom chemicals and cosmetics may damage the seat's finish. After installation, check the tightness of the bolts from time to time to ensure a tight fit.</p> |

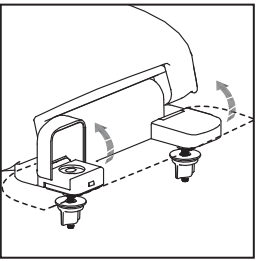
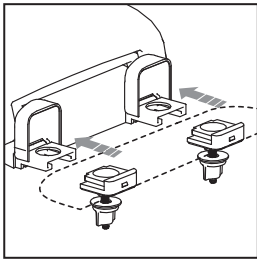
| | | |
|-------------------------------------|---|--|
| <p>SNAP-OFF INSTRUCTIONS</p> | <p>1</p>  <p>Open the hinge covers.</p> | <p>2</p>  <p>Slide seat forward to remove seat from posts.</p> |
|-------------------------------------|---|--|

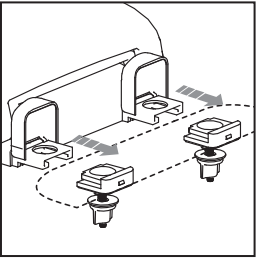
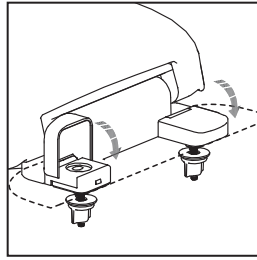
| | | |
|------------------------------------|--|--|
| <p>SNAP-ON INSTRUCTIONS</p> | <p>1</p>  <p>Slide seat onto seat posts.</p> | <p>2</p>  <p>Close the hinge covers.</p> |
|------------------------------------|--|--|

In the United States:
 American Standard Brands
 P.O. Box 6820
 Piscataway, New Jersey 08855
 Attention: Director of Customer Care
 For residents of the United States, warranty information may also be obtained by calling the following toll free number: (800) 442-1902
www.americanstandard.com

In Canada:
 AS Canada, ULC
 5900 Avebury Rd.
 Mississauga, Ontario
 Canada L5R 3M3
 Toll Free: (800) 387-0369
www.americanstandard.ca

In Mexico:
 American Standard B&K Mexico
 S. de R.L. de C.V.
 Via Morelos #330
 Col. Santa Clara
 Ecatepec 55540 Edo. Mexico
 Toll Free: 01-800-839-1200
www.americanstandard.com.mx

INSTRUCCIONES DE INSTALACIÓN

SNAP-OFF ASIENTO DE INODORO

American Standard

Style That Works Better

Modelo alargado: 5280.510, 5321.110, 5350.510, 5361.110, 5363.110, 5352.110

Modelo con la parte delantera redondeada: 5285.510, 5320.110, 5345.510, 5364.110, 5365.110, 5351.110

Gracias por elegir American Standard - Referencia de máxima calidad durante más de 100 años. Para asegurarse de que el producto esté instalado correctamente, lea estas instrucciones cuidadosamente antes de comenzar. (Determinadas instalaciones pueden requerir ayuda profesional.) Asegúrese de que su instalación cumpla con los códigos locales.

NOTA: es posible que las imágenes no ilustren con exactitud el asiento y los componentes.

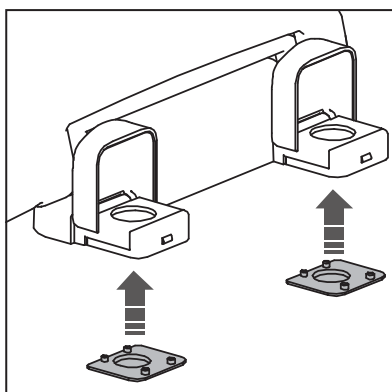
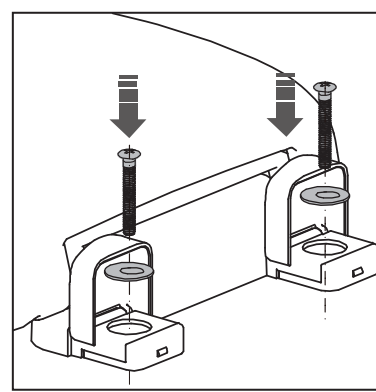
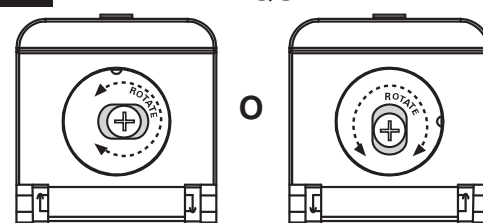
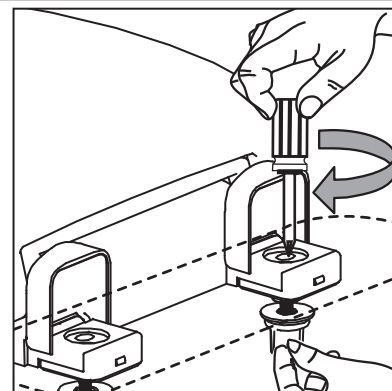
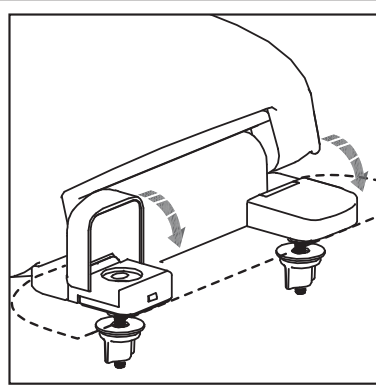
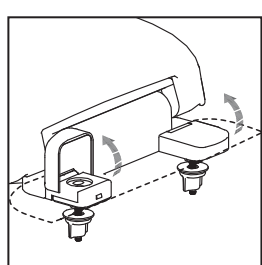
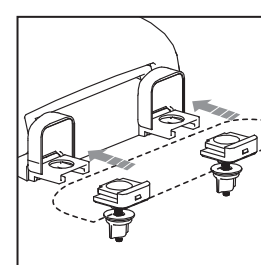
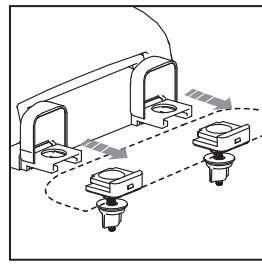
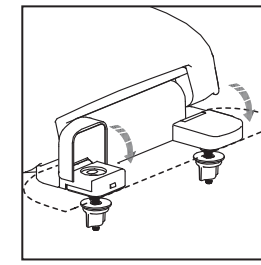
| | | |
|--|--|--|
| <p>1</p>  <p>Instale la base de goma en las bisagras.</p> | <p>2</p>  <p>Deslice los pernos a través de las tuercas, luego a través de las bisagras.</p> | <p>3 TANQUE</p>  <p>PARTE DELANTERA DE LA TAZA</p> <p>Las bisagras tienen arandelas ajustables integradas. Gire las arandelas según sea necesario para la mejor alineación del asiento sobre la taza del inodoro.</p> |
| <p>4</p>  <p>Enrosque las tuercas en los pernos. Apriete los pernos con un destornillador. NO APRETAR EN EXCESO.</p> | <p>5</p>  <p>Cierre las cubiertas de las bisagras. El asiento no funciona si las tapas de las bisagras no están cerradas firmemente.</p> | <p>Cuidado y limpieza</p> <p>Para limpiar el asiento del inodoro use agua jabonosa templada: enjuague bien el asiento con agua limpia y seque con un paño suave.</p> <p>Evite detergentes, desinfectantes o productos de limpieza en latas de aerosol. No utilice productos de limpieza en polvo abrasivos. Algunos cosméticos y productos químicos para baño pueden dañar el acabado del asiento. Luego de la instalación, verifique periódicamente que los pernos estén ajustados para garantizar la estabilidad del asiento.</p> |
| <p style="writing-mode: vertical-rl; transform: rotate(180deg);">INSTRUCCIONES PARA LA EXTRACCIÓN INSTANTÁNEA</p> <p>1</p>  <p>Abra las cubiertas de las bisagras.</p> | <p>2</p>  <p>Deslice el asiento hacia adelante para quitarlo de las bisagras.</p> | <p>En los Estados Unidos: American Standard Brands P.O. Box 6820 Piscataway, New Jersey 08855 Atención: Director de Servicio al Cliente Para los residentes en los Estados Unidos, la información de la garantía puede obtenerse también llamando al siguiente número sin cargo: (800) 442-1902 www.americanstandard.com</p> <p>En Canadá: AS Canada, ULC 5900 Avebury Rd. Mississauga, Ontario Canadá L5R 3M3 Número sin cargo: (800) 387-0369 www.americanstandard.ca</p> |
| <p style="writing-mode: vertical-rl; transform: rotate(180deg);">INSTRUCCIONES PARA LA COLOCACIÓN A PRESIÓN</p> <p>1</p>  <p>Deslice el asiento hacia las bisagras.</p> | <p>2</p>  <p>Cierre las cubiertas de las bisagras.</p> | <p>En México: American Standard B&K México S. de R. L. de C.V. Vía Morelos #330 Col. Santa Clara Ecatepec 55540 Edo. México Número sin cargo: 01-800-839-1200 www.americanstandard.com.mx</p> |

INSTRUCTIONS D'INSTALLATION

SNAP-OFF SIÈGE DE TOILETTE

American Standard

Style That Works Better

Modèle allongé: 5280.510, 5321.110, 5350.510, 5361.110, 5363.110, 5352.110

Modèle avec Devant arrondi: 5285.510, 5320.110, 5345.510, 5364.110, 5365.110, 5351.110

Nous vous remercions d'avoir choisi Eljer - synonyme de qualité supérieure depuis plus de 100 ans. Pour être sûr que ce produit soit bien installé, veuillez lire attentivement ces instructions avant de commencer. (Certaines installations peuvent requérir une aide professionnelle.) Assurez-vous également que votre installation soit conforme aux codes locaux.

REMARQUE : Les dessins peuvent ne pas représenter exactement le siège de la toilette et les composants

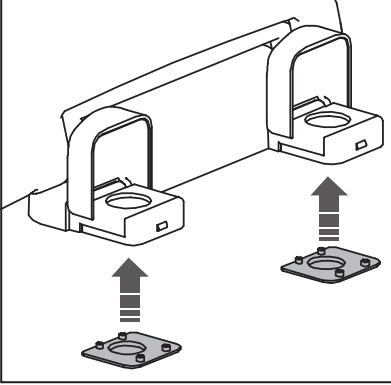
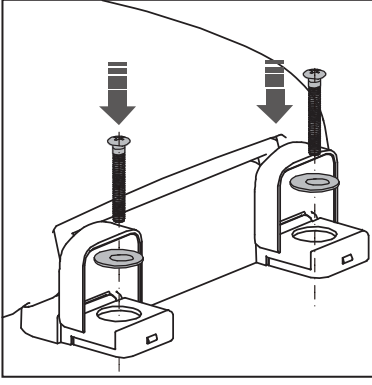
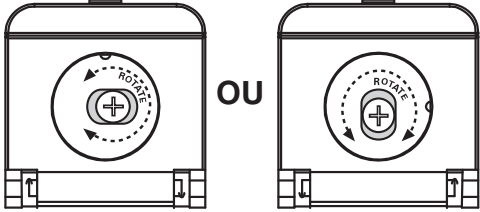
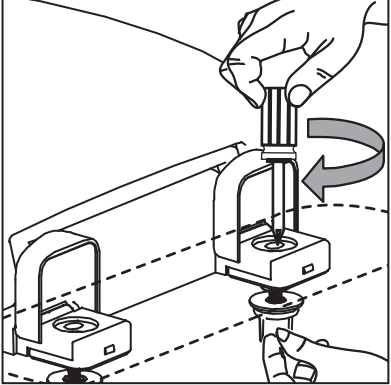
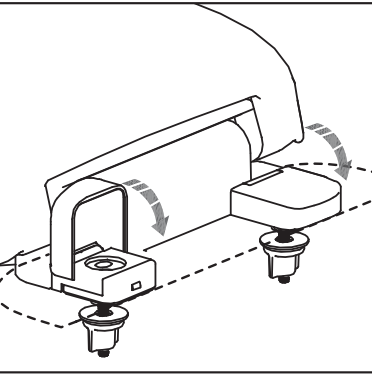
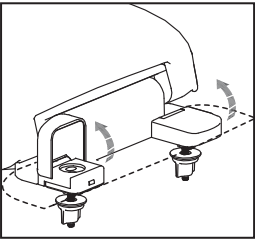
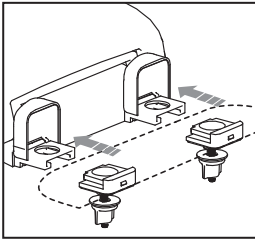
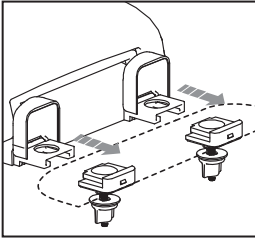
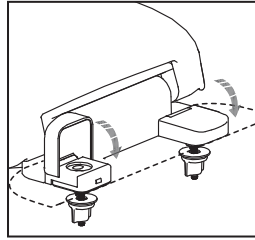
| | | |
|--|---|---|
| <p>1</p>  <p>Installer les patins en caoutchouc sur la base des charnières.</p> | <p>2</p>  <p>Engager les vis à travers les rondelles et ensuite à travers les trous des charnières.</p> | <p>3</p> <p>RÉSERVOIR</p>  <p>OU</p> <p>AVANT DE LA CUVETTE</p> <p>Les charnières sont pourvues de rondelles réglables. Faire tourner les rondelles au besoin pour bien aligner le siège sur la cuvette.</p> |
| <p>4</p>  <p>Engager les écrous sur les vis. Serrer les boulons à l'aide d'un tournevis. NE PAS TROP SERRER.</p> | <p>5</p>  <p>Rabattre les cache-charnières. Le siège de toilette ne sera correctement installé que si les couvercles de charnière ferment totalement.</p> | <p>ENTRETIEN ET NETTOYAGE</p> <p>Pour nettoyer le siège de la toilette, laver avec de l'eau et un savon doux : rincer abondamment à l'eau propre et essuyer avec un chiffon doux.</p> <p>Éviter les détergents, désinfectants ou les produits de nettoyage en aérosol. Ne jamais utiliser de poudres à récurer abrasives sur votre siège de toilette. Certains produits chimiques et cosmétiques pour salles de bains peuvent endommager le fini du siège. Après l'installation, vérifier de temps à autre si les boulons sont bien serrés.</p> |
| <p>RETRAIT RAPIDE</p> <p>1</p>  <p>Ouvrir les cache-charnières.</p> | <p>2</p>  <p>Tirer le siège en avant afin de libérer les charnières de leur supports.</p> | <p>Aux États-Unis: American Standard Brands P.O. Box 6820 Piscataway, New Jersey 08855 Attention: Directeur du Service à la clientèle Les résidents des États-Unis peuvent aussi obtenir des informations à propos de la garantie en composant le numéro sans frais (800) 442-1902 www.americanstandard.com</p> <p>Au Canada: AS Canada, ULC 5900 Avebury Rd. Mississauga, Ontario Canada L5R 3M3 Sans frais: (800) 387-0369 www.americanstandard.ca</p> |
| <p>FIXATION PAR ENCLIQUEMENT</p> <p>1</p>  <p>Pousser afin d'engager les charnières dans leur supports.</p> | <p>2</p>  <p>Rabattre les cache-charnières.</p> | <p>Au Mexique : American Standard B&K Mexique S. de R.L. de C.V. Via Morelos n° 330 Col. Santa Clara Ecatepec 55540 Edo. Mexico Sans frais: 01-800-839-1200 www.americanstandard.com.mx</p> |