

C83



## Assembly & Installation Instructions

# Assembly & Installation Instructions

Cumulus Floor Lamp 249701 & 249701C

---



## Contents

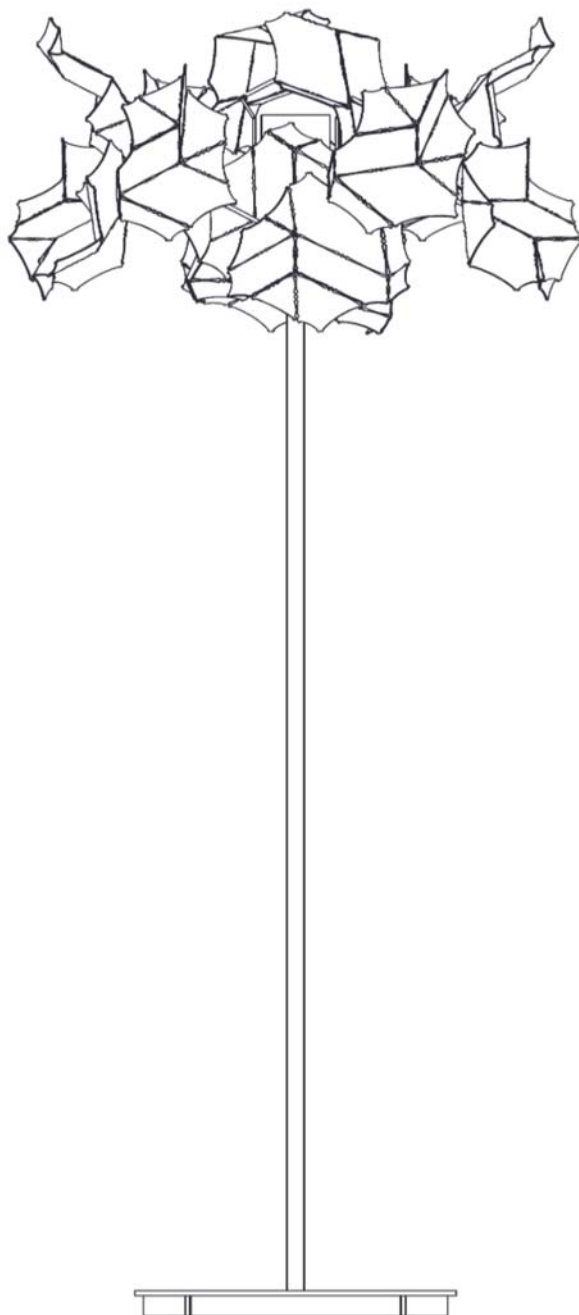

Castleton, Vermont USA | VERMONTMODERN.COM

37486

# Assembly & Installation Instructions



Cumulus Floor Lamp 249701 & 249701C

---

## Component Parts

- A Accent
- B Base Assembly
- C Accent
- D #8 Screw (2)
- E Bulb (not included)
- F Glass
- G Socket
- H Accent (2)
- I Accent (2)
- J Bent Plate with Tube (4)



# Assembly & Installation Instructions

C83

## Cumulus Floor Lamp 249701 & 249701C

**CAUTION: FAILURE TO INSTALL THIS FIXTURE PROPERLY MAY RESULT IN SERIOUS PERSONAL INJURY OR DEATH AND PROPERTY DAMAGE.** We recommend installation by a licensed electrician. This product must be installed in accordance with applicable installation code(s), by a person familiar with the construction and operation of the product and the hazards involved.\*

Caution: Do not exceed maximum wattage noted on fixture. Use only recommended bulbs with fixture.

Please Note: After installation extra hardware and accessories are possible due to our kits are used on multiple products and options.

### Complete Lamp Assembly (Figure 1)

1. Carefully unpack the fixture from the box.
2. Slide accent (A) over base assembly (B) with bent rods pointing towards the floor. Let accent (A) rest on case assembly (B). (Figure 1)

Note: The round plate on top of base assembly (B) will pass through the ring plate inside accent (A).

3. Slide the slot in accent (C) around the socket (G). Align the screw holes in accent (C) with the holes in the round plate. Secure accent (C) to round plate with two #8 screws (D). (Figure 2)
4. Install bulb (E) (not included) and place glass (F) over the socket (G). Center the glass around the socket (G).

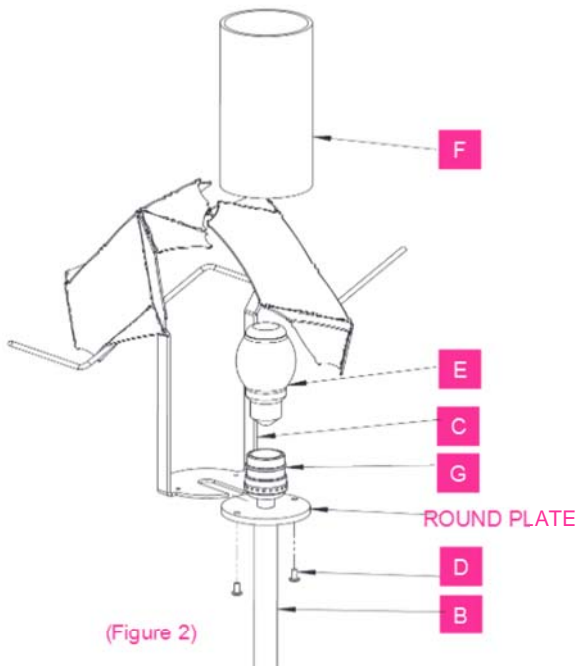

(Figure 2)

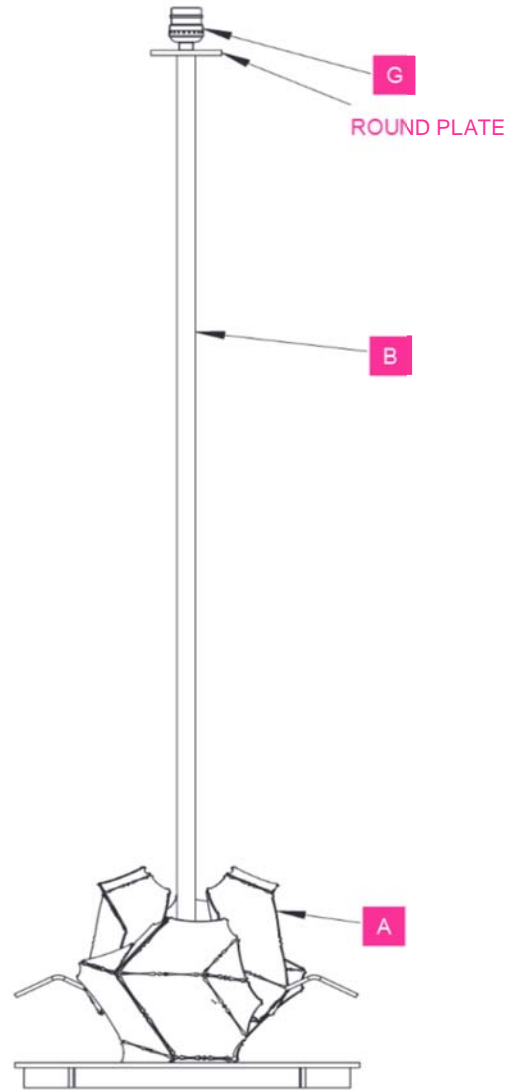

(Figure 1)



If you need further assistance, or if you find that you are missing any parts, please contact the dealer from which you purchased this product. We hope you enjoy your fixture. Hubbardton Forge will not be liable for injury or damage caused by improper installation, lamping or use of this fixture.

Castleton, Vermont USA | VERMONTMODERN.COM

37486

# Assembly & Installation Instructions

C83

## Cumulus Floor Lamp 249701 & 249701C

5. Orient both pieces of accent (H) so they are parallel to each other with the plates to the outside of the bent rods. (Figure 3) The exposed bent rod from accent (C) will pass through the hole in the plate on accent (H) in order to attach accent (H). (Figure 4)

Note: The plate on accent (H) will have only a hole to attach the accent. (Figure 3)

Note: As long as the plates picture (Figure 3) are kept to the outside of the rods you can approach the structure from either side.

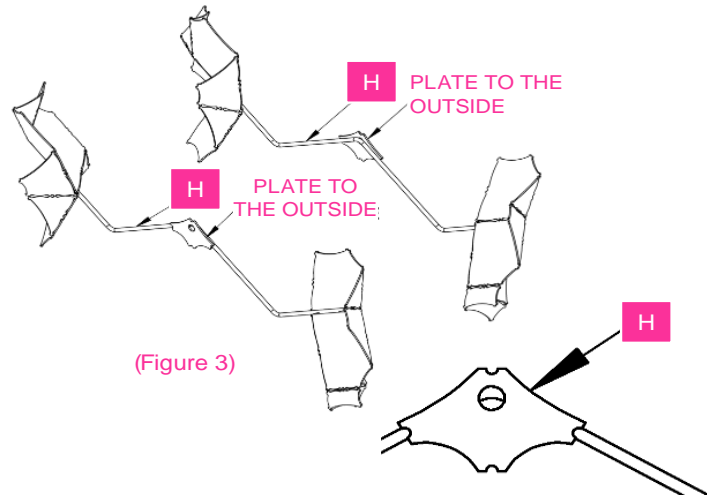

6. Orient both pieces of accent (I) so they are parallel to each other with the plates pictured on the outside of the bent rods and the slot above the hole. (Figure 5) Lift both accents (I) and slowly lower them down onto the open bends on accent (H).

Note: The plate on accent (I) will have a hole to attach it as well as a vertical slot above the hole. (Figure 5)

Note: As long as the plates picture (Figure 5) are kept to the outside of the rods you can approach the structure from either side.

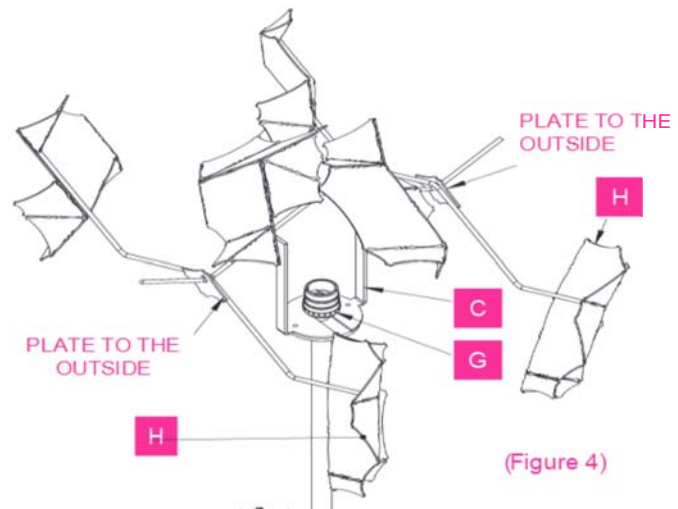

7. Carefully raise accent (A) until the bent arms from accent (A) can slide through the holes in the plates of each accent (I).

Note: Be careful not to knock the glass while installing accent (A)

Note: When accent (A) is fully installed it will hang balanced around the glass (F). While installing bent plates with tube (J) in the following steps remember this orientation is balanced.

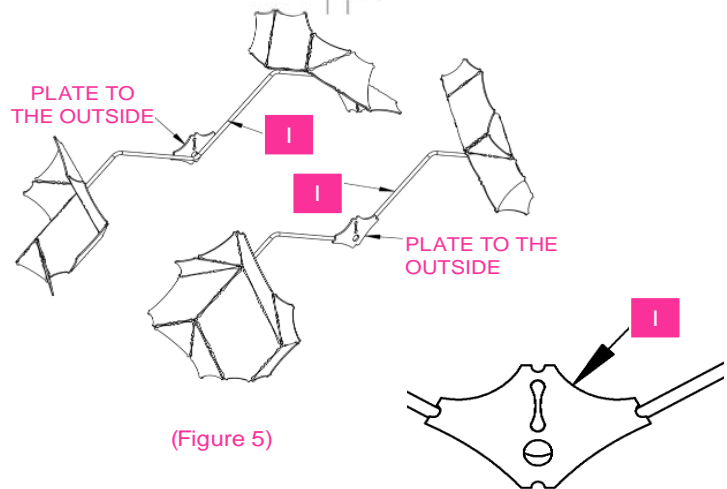

# Assembly & Installation Instructions

C83

Cumulus Floor Lamp 249701 & 249701C

- Slide the bent plate with tube (J) onto the bent rod of accent (C) with the set screws facing up; tighten the set screw. (Figure 6 & 7)
- Repeat step 8 for the other bent arm of accent (C).
- Locate the remaining two bent plates with tubes (J) and the two bent arms on accent (A).
- Slide one of the bent plates with tube (J) onto one of the bent arms of accent (A) with the set screws facing down; tighten the set screw.

Note: This will make accent (A) unbalanced around the glass (F)

- Rotate accent (A) until it is back to the balanced orientation that it had before you installed the first bent plate with tube (J) onto accent (A).
- With accent (A) held balanced slide the last bent plate with tube (J) onto the bent arm of accent (A) with the set screws facing down; tighten the set screw
- Plug the power cord coming from the base assembly (B) into the dimmer located in the kit bag. Plug the dimmer into the wall.

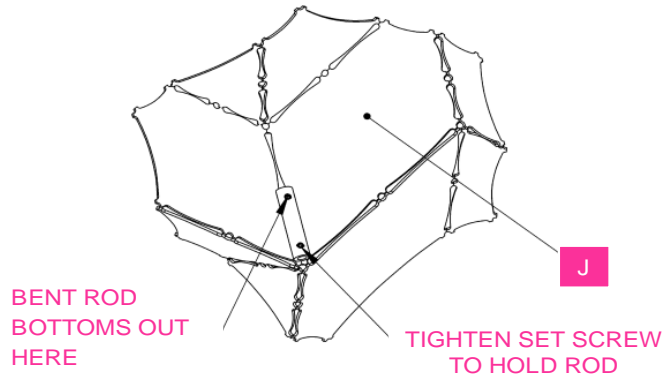

(Figure 6)

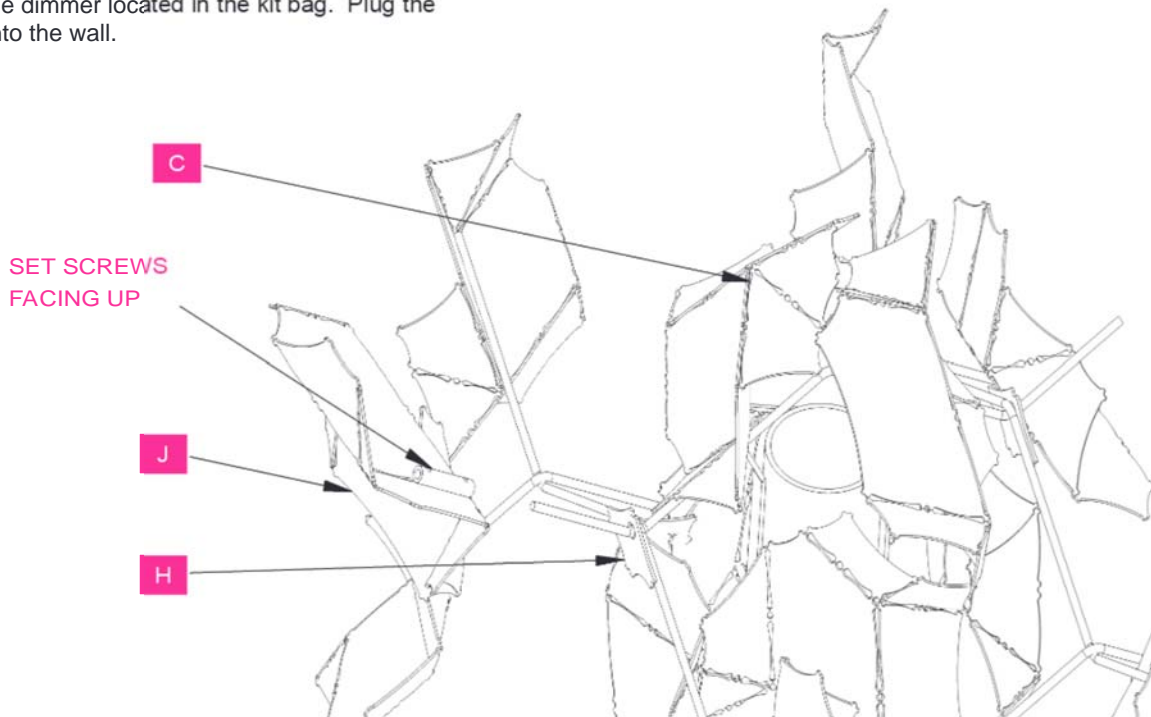

Castleton, Vermont USA | VERMONTMODERN.COM

37486