



Specification:

1. Material: WD
2. Finish: Blue
3. Hardware: 658SBZ (3 PCS)
4. Slides: USE58-300-18 + US-CLIP-4W (1 Sets)
5. Shelf Supports: 1707BN (4 PCS)
6. Drawer Boxes: 5/8" Rubber wood
Clear color
Dovetail
7. Hinge: 700.0537.05 with 600.1233.05 plate
8. Bowl: H8809WH
9. The tolerance is +/- 1/8"

	ITEM#: VN-CHA-24-BL-XX		MATERIAL:		
	FINISH:		WEIGHT:		
PROPRIETARY AND CONFIDENTIAL THE INFORMATION CONTAINED IN THIS DRAWING IS THE SOLE PROPERTY OF HARDWARE RESOURCES INC. ANY REPRODUCTION IN PART OR AS A WHOLE WITHOUT THE WRITTEN PERMISSION OF HARDWARE RESOURCES INC. IS PROHIBITED.	TOLERANCE UNLESS OTHERWISE SPECIFIED: X ±0.20 X.X ±0.10 X.XX ±0.05 ANGULAR: ±0.5°		UNITS:	DRAWN BY: Alexander.W	DATE: 09-18-18
	DO NOT SCALE DRAWING		SIZE:	APPROVED BY:	DATE:
			SHEET:	RELEASE LEVEL:	REVISION:
			PROJECTION 		

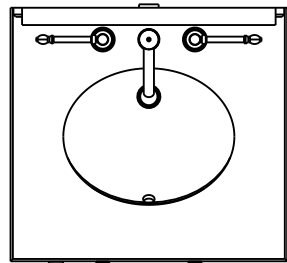
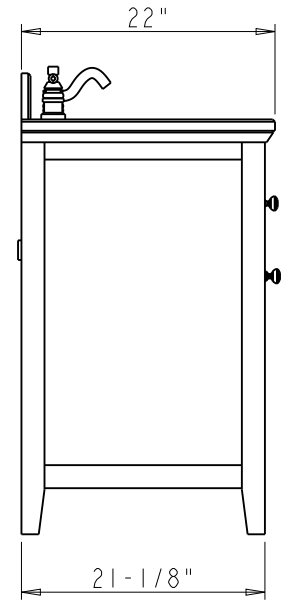
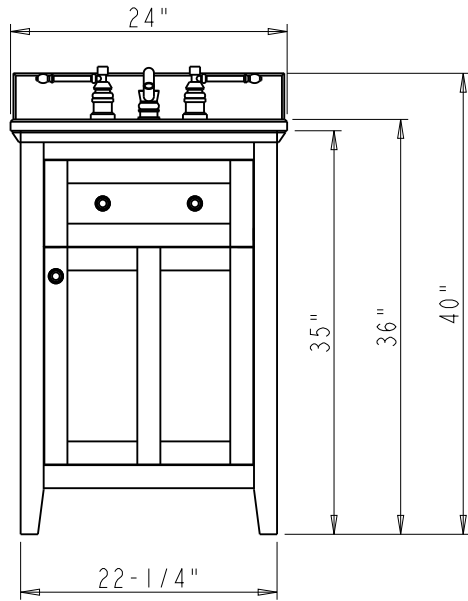
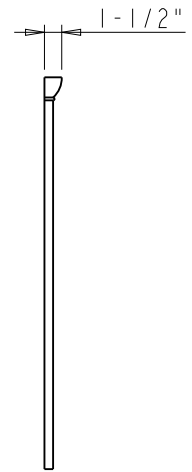
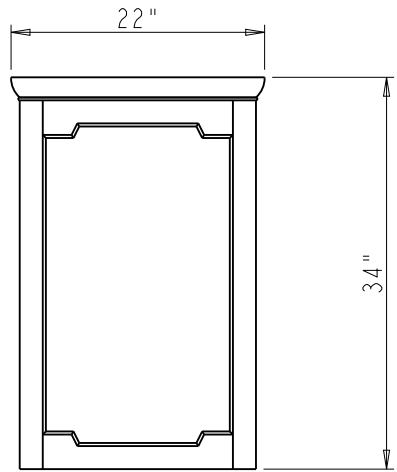

	ITEM#: VN-CHA-24-BL-XX		MATERIAL:		
	FINISH:		WEIGHT: 9		
<p>PROPRIETARY AND CONFIDENTIAL</p> <p>THE INFORMATION CONTAINED IN THIS DRAWING IS THE SOLE PROPERTY OF HARDWARE RESOURCES INC. ANY REPRODUCTION IN PART OR AS A WHOLE WITHOUT THE WRITTEN PERMISSION OF HARDWARE RESOURCES INC. IS PROHIBITED.</p>	TOLERANCE UNLESS OTHERWISE SPECIFIED:		PROJECTION		
	UNITS: X ±0.20 X.X ±0.10 X.XX ±0.05 ANGULAR: ±0.5°	DRAWN BY: Alexander.W	DATE: 09-18-18		
	SIZE: SHEET:	APPROVED BY:	DATE:		
	DO NOT SCALE DRAWING	RELEASE LEVEL:	REVISION:		

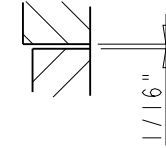
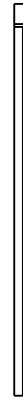
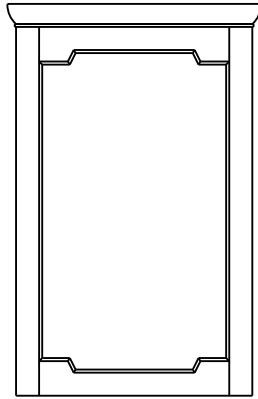

DETAIL A
SCALE 2:5

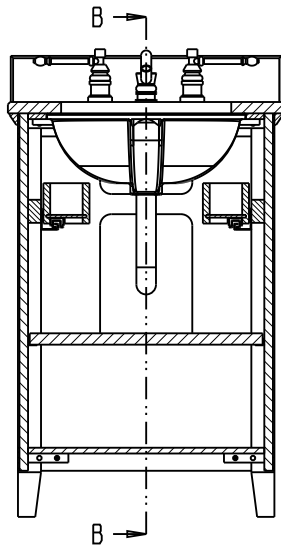

SECTION A-A

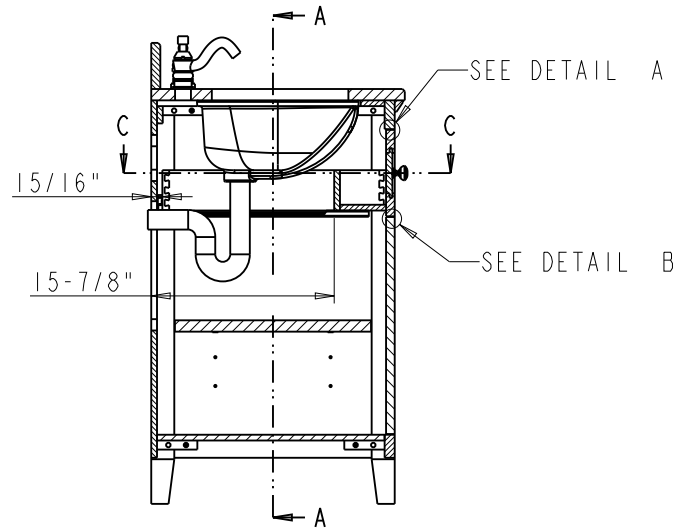

SECTION B-B
SCALE 3:50

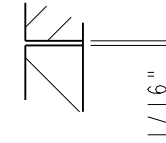

DETAIL B
SCALE 2:5

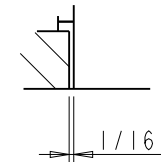

DETAIL C
SCALE 2:5

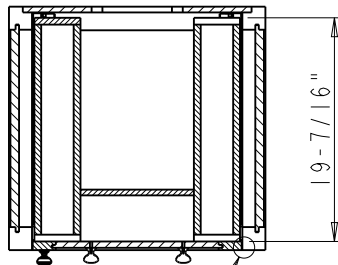

SEE DETAIL C
SECTION C-C

	ITEM:	VN-CHA-24-BL-XX		MATERIAL:
	FINISH:			WEIGHT:
<p>PROPRIETARY AND CONFIDENTIAL</p> <p>THE INFORMATION CONTAINED IN THIS DRAWING IS THE SOLE PROPERTY OF HARDWARE RESOURCES INC. ANY REPRODUCTION IN PART OR AS A WHOLE WITHOUT THE WRITTEN PERMISSION OF HARDWARE RESOURCES INC. IS PROHIBITED.</p>	TOLERANCE UNLESS OTHERWISE SPECIFIED:	UNITS:	DRAWN BY:	DATE:
	X ±0.20		Alexander.W	09-18-18
	X.X ±0.10	SIZE:	APPROVED BY:	DATE:
	X.XX ±0.05	SHEET:	RELEASE LEVEL:	REVISION:
ANGULAR: ±0.5°	DO NOT SCALE DRAWING			