









Location:

# Origins™

## S-9603-PLR Hand Shower System Specification Submittal



Model Numbers	Specification
<input type="checkbox"/> <b>S-9603-PLR</b> <i>Origins Hand Shower System</i>	<p>Hand shower system powered by the Temptrol® Pressure Balancing valve. Features adjustable stop screw to limit handle turn, integrated volume control, 36" slide bar, in-line vacuum breaker, 60" flexible metal hose, ADA hand shower and standard 2.5 gpm (9.5 L/min) flow restrictor. Components made from metal and nonmetallic materials plated in standard polished chrome finish.</p> <div style="text-align: right;">   </div>
<p><b>Modifications</b></p> <ul style="list-style-type: none"> <li><input type="checkbox"/> <b>-1.5</b>  1.5 gpm (5.7 L/min) flow restrictor</li> <li><input type="checkbox"/> <b>-2.0</b>  2.0 gpm (7.6 L/min) flow restrictor</li> <li><input type="checkbox"/> <b>-X</b> Integral service stops</li> <li><input type="checkbox"/> <b>-CHKS</b> Integral check stops</li> <li><input type="checkbox"/> <b>-IPS</b> 1/2" female IPS connections</li> <li><input type="checkbox"/> <b>-REV</b> Reverse coring for back to back installations</li> <li><input type="checkbox"/> <b>-LP</b> Loop handle</li> <li><input type="checkbox"/> <b>-B</b> Chrome brass escutcheon</li> <li><input type="checkbox"/> <b>-D</b> Chrome brass dome cover</li> <li><input type="checkbox"/> <b>-VP</b> Vandal proof escutcheon screws</li> <li><input type="checkbox"/> <b>-QD</b> Quick disconnect on hand shower units</li> <li><input type="checkbox"/> <b>-R</b> White vinyl hose in place of metal hose</li> <li><input type="checkbox"/> <b>-VB</b> Elevated vacuum breaker</li> <li><input type="checkbox"/> <b>-OP</b> 13" oval plate</li> <li><input type="checkbox"/> <b>-72</b> 6' hose in place of 5' standard</li> <li><input type="checkbox"/> <b>-B30</b> 30" adjusting bar in place of standard 36" bar</li> <li><input type="checkbox"/> <b>-B48</b> 48" adjusting bar in place of standard 36" bar</li> <li><input type="checkbox"/> <b>-L/GB</b> Less grab bar</li> <li><input type="checkbox"/> <b>-T24</b> 24" grab bar in place of standard 36" bar</li> <li><input type="checkbox"/> <b>-TRM</b> Trim only, valve not included</li> <li><input type="checkbox"/> <b>-STN</b> Satin Nickel finish</li> </ul> <p><b>Note:</b> Append appropriate -suffix to model number.</p>	<p><b>Compliance</b></p> <ul style="list-style-type: none"> <li>-ASME A112.18.1/CSA B125.1</li> <li>-WaterSense 1.5 gpm (5.7 L/min) 2.0 gpm (7.6 L/min)</li> </ul> <div style="text-align: right;">   </div> <p><b>Warranty</b></p> <p><b>Limited Lifetime</b> - to the original end purchaser in consumer/residential installations.  <b>5 Years</b> - for industrial/commercial installations.  Refer to <a href="http://www.symmons.com/warranty">www.symmons.com/warranty</a> for complete warranty information.</p>

## Dimensions

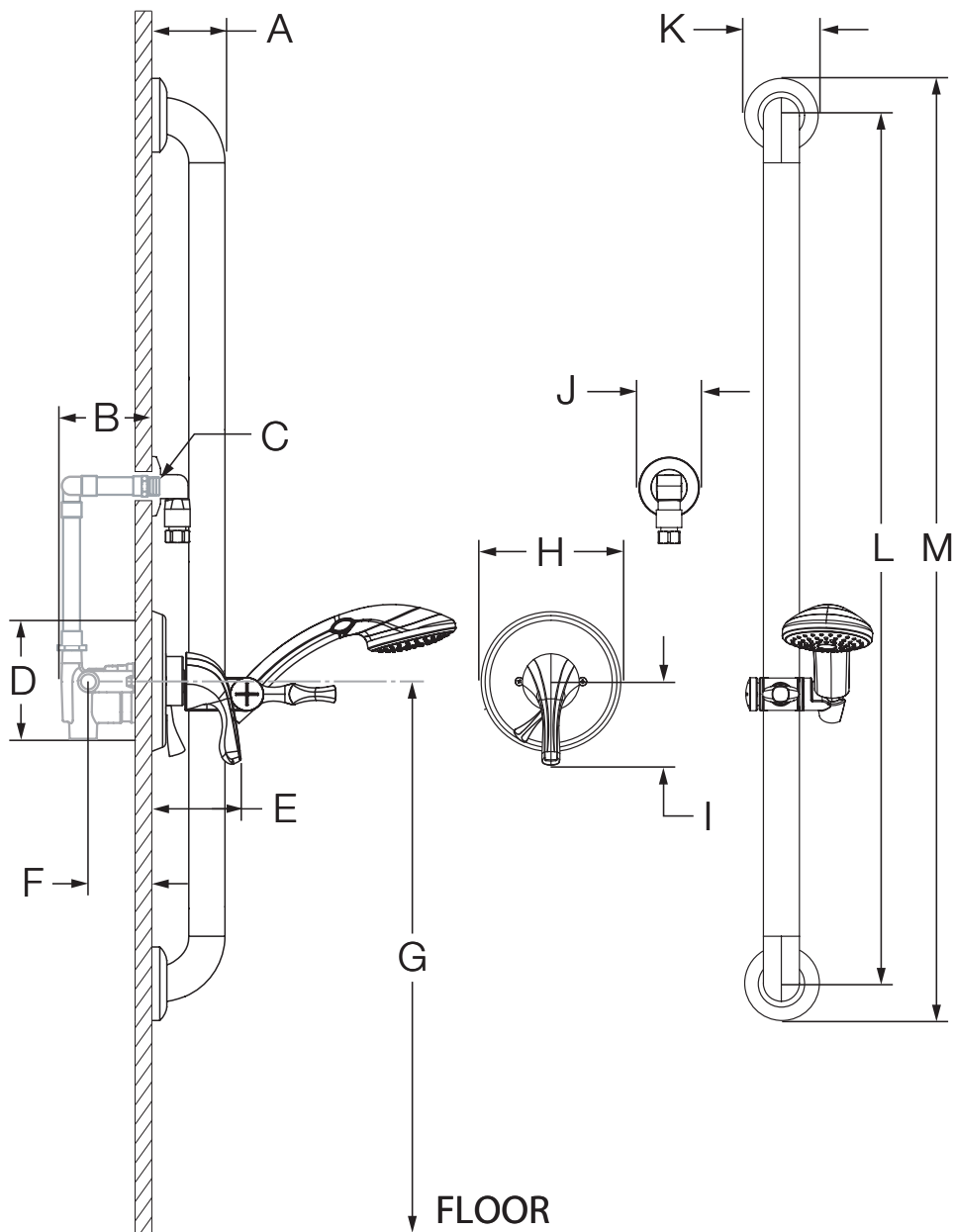

Measurements	
A	3", 76 mm
B	3 1/2", 89 mm
C	Male 1/2" NPT fitting must protrude 3/8" from finished wall
D	Shower Valve Hole Size Min. Ø 3", 76 mm Max. Ø 4", 102 mm
E	3 5/8", 92 mm
F	Rough-in 2 3/8" ± 1/2", 60 mm ± 13 mm
G	Ref. 32", 813 mm
H	Ø 5 3/4", 146 mm
I	3 3/8", 86 mm
J	Ø 2 1/2", 64 mm
K	Ø 3 1/8", 79 mm
L	36", 914 mm
M	39", 991 mm

### Notes:

- 1) All dimensions measured from nominal rough-in (see F as reference).
- 2) Dimensions subject to change without notice.

Emplacement:









# Origins™

S-9603-PLR

Système douche à main

## Présentation des spécifications



Numéro de modèle	Spécification
<input type="checkbox"/> <b>S-9603-PLR</b> <i>Système douche à main Origins</i>	<p>Le système de douche à main comprend la vanne à pression autorégulée Temptrol®. Figurer la vis d'arrêt réglable pour limiter le tournage de la poignée, contrôle du volume entier, une barre de glissement de 36 po, 60 po tuyau flexible en métal et 1 douche à main avec un réducteur de débit régulier de 2,5 gpm (9,5 L/min). Les composants sont faits de matériaux métalliques et non métalliques au fini chrome poli standard.</p> <div style="text-align: right;">   </div>
<p><b>Modifications</b></p> <ul style="list-style-type: none"> <li><input type="checkbox"/> <b>-1.5</b>  Régulateur de débit de 1,5 gpm (5,7 L/min)</li> <li><input type="checkbox"/> <b>-2.0</b>  Régulateur de débit de 2,0 gpm (7,6 L/min)</li> <li><input type="checkbox"/> <b>-X</b> Robinet d'interruption du service</li> <li><input type="checkbox"/> <b>-CHKS</b> Valve d'arrêt intégrée</li> <li><input type="checkbox"/> <b>-IPS</b> Raccords IPS femelles de 1/2 po</li> <li><input type="checkbox"/> <b>-REV</b> Corps central inversé our installations dos à dos</li> <li><input type="checkbox"/> <b>-LP</b> Poignée en boucle</li> <li><input type="checkbox"/> <b>-B</b> Vanne de la rosace chrome laiton</li> <li><input type="checkbox"/> <b>-D</b> Couvercle en dôme chrome laiton</li> <li><input type="checkbox"/> <b>-VP</b> Vis de rosace résistant au vandalisme</li> <li><input type="checkbox"/> <b>-QD</b> Débranchement rapide pour de douche à main</li> <li><input type="checkbox"/> <b>-R</b> Tuyau de vinyle blanc</li> <li><input type="checkbox"/> <b>-VB</b> Reniflard surélevé</li> <li><input type="checkbox"/> <b>-OP</b> Assiette ovale 13 po</li> <li><input type="checkbox"/> <b>-72</b> Tuyau de 6' au lieu de 5' standard</li> <li><input type="checkbox"/> <b>-B30</b> Réglage barre 30 po à la place de la barre standard</li> <li><input type="checkbox"/> <b>-B48</b> Réglage barre 48 po à la place de la barre standard</li> <li><input type="checkbox"/> <b>-L/GB</b> Aucune barre d'appui</li> <li><input type="checkbox"/> <b>-T24</b> Barre d'appui 24 po à la place de la barre standard</li> <li><input type="checkbox"/> <b>-TRM</b> Garniture seulement, vanne non incluse</li> <li><input type="checkbox"/> <b>-STN</b> Fini nickel satiné</li> </ul> <p><b>Remarque:</b> Juxtaposer le -suffixe approprié au numéro de modèle.</p>	
	<p><b>Conforme</b></p> <ul style="list-style-type: none"> <li>-ASME A112.18.1/CSA B125.1</li> <li>-WaterSense 1.5 gpm (5.7 L/min) 2.0 gpm (7.6 L/min)</li> </ul> <div style="text-align: right;">   </div>
	<p><b>Garantie</b></p> <p><b>À vie limitée</b> - à l'acheteur original dans les installations du consommateur ou résidentielles.  <b>5 ans</b> - pour des installations commerciales et industrielles.          Se reporter au site <a href="http://www.symmons.com/warranty">www.symmons.com/warranty</a> (en anglais) pour l'information complète concernant la garantie.</p>

## Dimensions

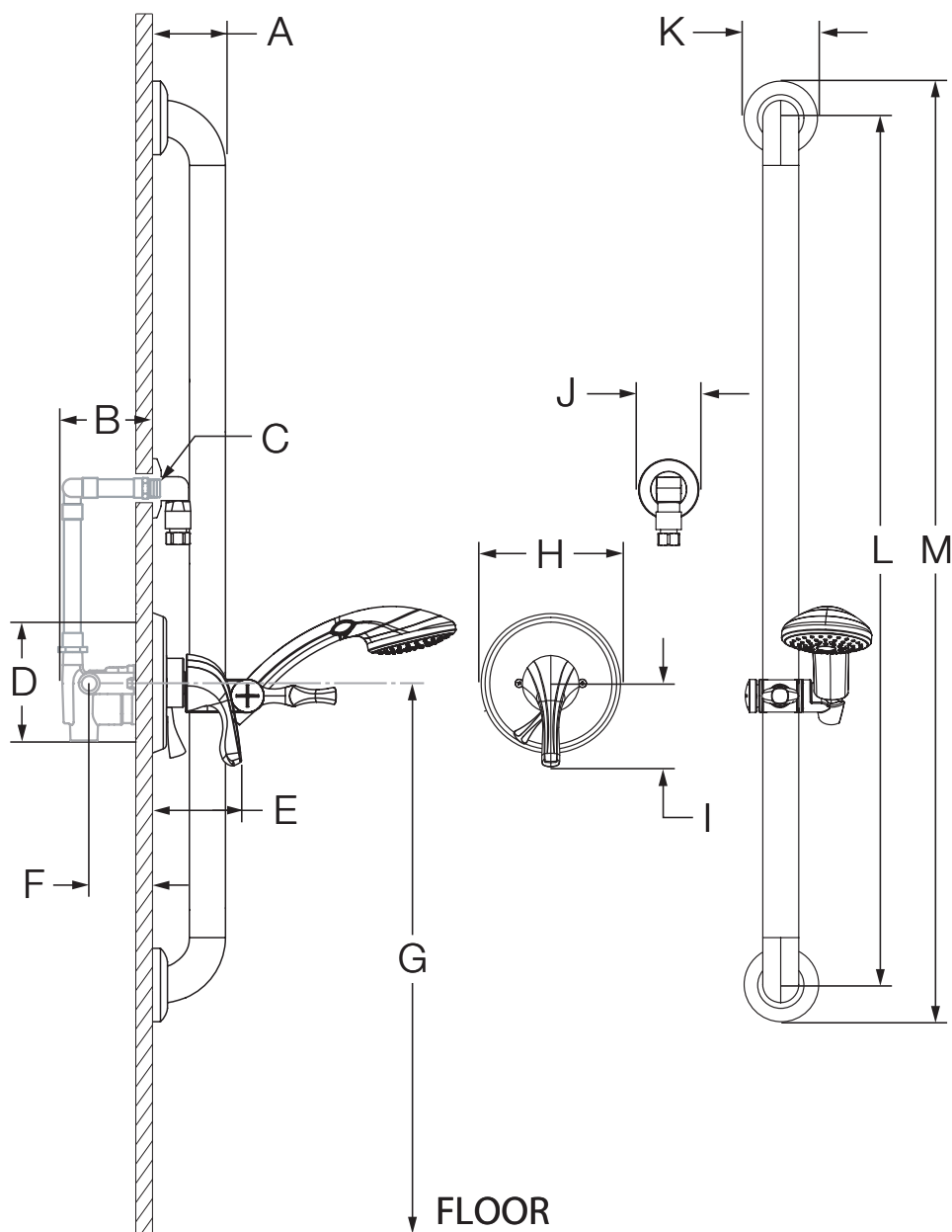

Mesures	
A	3 po, 76 mm
B	3 1/2 po, 89 mm
C	1/2 po mâle à filets NPT doit faire saillie de 3/8 po du mur fini
D	Taille du trou Min. Ø 3 po, 76 mm Max. Ø 4 po, 102 mm
E	3 5/8 po, 92 mm
F	Robinetterie brute 2 3/8 po ± 1/2 po, 60 mm ± 13 mm
G	Réf. 32 po, 813 mm
H	Ø 5 3/4 po, 146 mm
I	3 3/8 po, 86 mm
J	Ø 2 1/2 po, 64 mm
K	Ø 3 1/8 po, 79 mm
L	36 po, 914 mm
M	39 po, 991 mm

### Remarques:

- 1) Toutes les dimensions sont mesurées à partir de la robinetterie brute nominale (voir F en référence).
- 2) Les dimensions sont sujettes à changer sans préavis.