

Replacement Parts For **MR1126** 7/2012

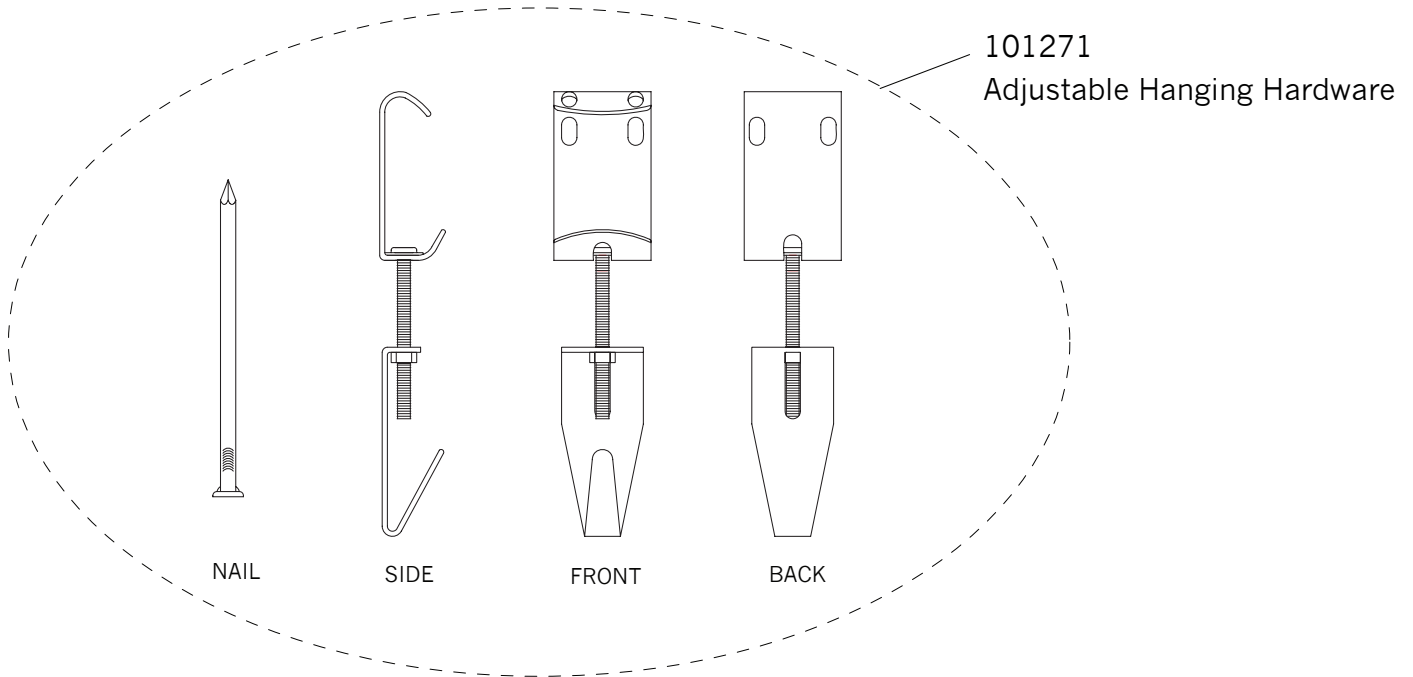
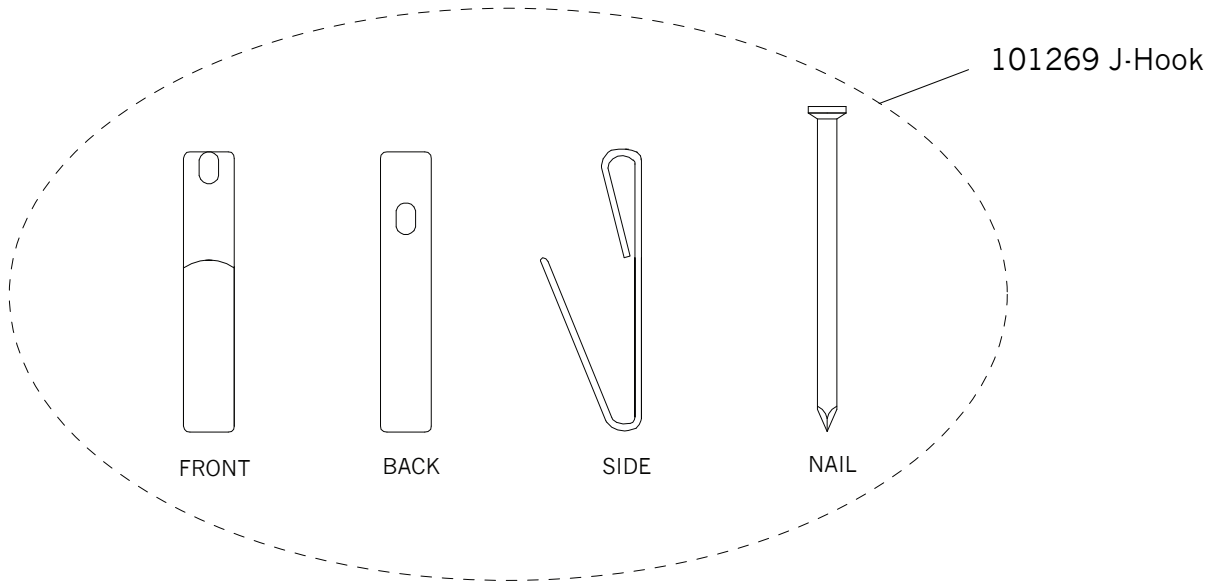
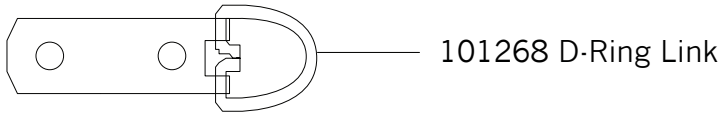

Qty.	Part #	Description
	101268	D-Ring Link
	101269	J-Hook
	101271	Adjustable Hanging Hardware