

CARE AND MAINTENANCE

Unplug lamps before using any cleaning solutions. Dust shades with a feather duster or with an appropriate









vacuum-brush attachment. Wipe with a soft, dry cloth and clean lamp bases with the methods appropriate to the material. Avoid the use of chemicals and household cleaners as they may damage the finish.

NOTICE & IMPORTANT SAFETY INSTRUCTIONS

- * Please make sure that you have all parts indicated before you begin assembly of this item
- * This item should be assembled on a soft surface to prevent scratching the finish during assembly
- * To reduce the risk of fire, electrical shock or injury to persons or property, please follow the guideline below for safe use and installation
- *The external flexible cable or cord of this luminaire cannot be replaced;
If the cord is damaged, the luminaire shall be destroyed

**This portable lamp has a polarized plug (one blade is wider than the other) as a safety feature to reduce the risk of electric shock. this plug will fit in a polarized outlet only one way. if the plug does not fit fully in the outlet, reverse the plug, if it still does not fit, contact a qualified electrician. Never use with an extension cord unless the plug can be fully inserted. do not attempt to defeat this safety feature.

Part List and Hardware List

PIECE	DESCRIPTION	PICTURE	QUANTITY	PIECE	DESCRIPTION	PICTURE	QUANTITY
A	Lamp base		1X	F	Harp		1X
B	Tube		1X	G	Shade		1X
C	Clomn		1X	H	Finial		1X
D	Saddle		1X	I	Bulb		1X
E	Socket		1X				



Model# LIT4044A

Product Dimensions: 12"Lx 12"W x 32.5"H

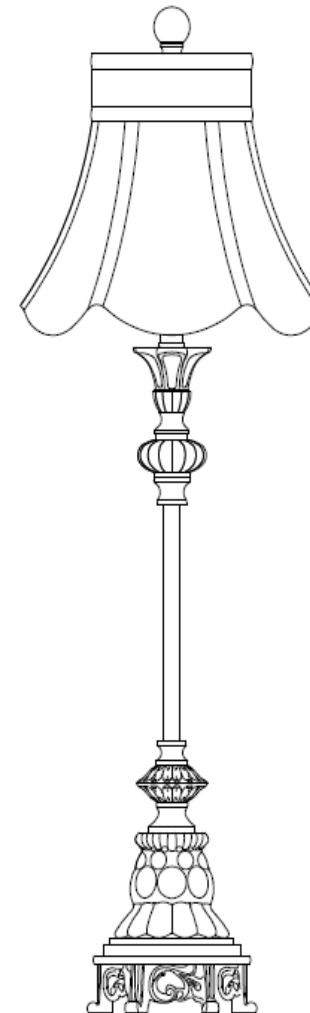

PREPARATION

Before beginning assembly of product, make sure all parts are present. Compare parts with package contents list and hardware contents list. If any part is missing or damaged, do not attempt to assemble the product.

Estimated Assembly Time: 6 minutes.

1

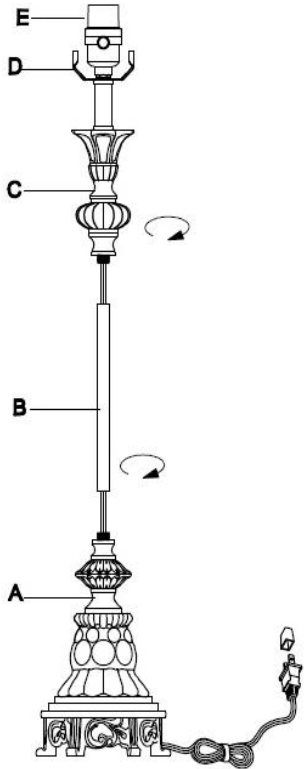

2

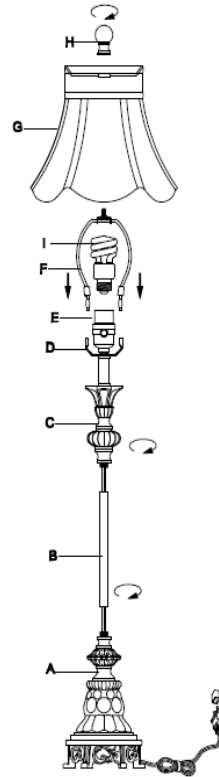

3

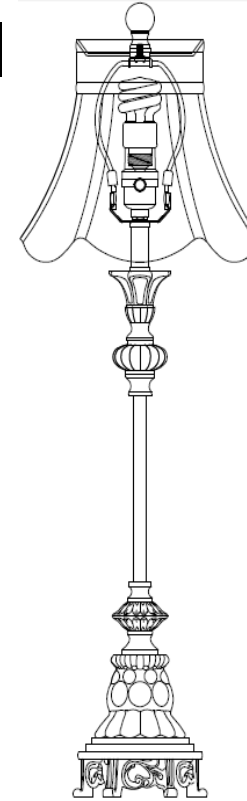

Step 1

Screw the Tube (B) onto the Lamp base (A),
Then screw column (C) onto Tube (B),
Be careful not to twist the power cord and tighten securely

Step2

Insert the Harp (F) into the Saddle (D).
Put the shade(G) on the Harp(F),then
tighten the Finial (H)into the Harp (F)
Insert the bulb(I) into the socket(E).

Step3

Put the light on a level surface to check
if everything is stable.

ENJOY YOUR LAMP