

Kräus[®]

INSTALLATION MANUAL

Fireclay Workstation Farmhouse Kitchen Sink

KFR4-33GWH

Thank you for your purchase

We would like to take this opportunity to thank you for choosing Kraus. We hope that you are completely satisfied with your purchase, and enjoy it for years to come. If you have any questions, or require technical assistance, please contact us at 800.775.0703 and one of our representatives will be happy to help.

For more information about Kraus products, please visit:

www.kraususa.com

In order to activate your warranty and get faster access to customer support, please register your new Kraus product at:

www.kraususa.com/registration

Sincerely,

Kraus USA Customer Service

Prior to Installation:

- Inspect the sink prior to installation to make sure the sink has not been damaged during shipping.
- Observe all plumbing and building codes according to your state requirements.
- Additional floor and wall preparation may be required to avoid damaging the sink.
- Make sure to purchase the correct cabinet for your farmhouse sink. Farmhouse base cabinets should be 3" larger than the actual size of the sink.
- Not recommended to be installed with laminate countertop.





For technical assistance or replacement parts, please contact Kraus

Customer Service and one of our representatives will be happy to help:

Toll-Free: 800-775-0703 or customerservice@kraususa.com

The step-by-step guidelines in the installation instructions are a general reference for installing a Kraus Sink. Should there be any discrepancies, Kraus cannot be held liable. It is recommended to install all Kraus products by hiring a licensed professional.

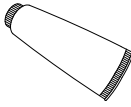
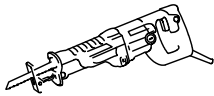
Tools you will need:

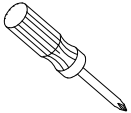
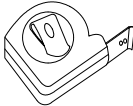
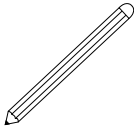
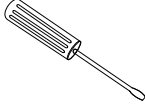
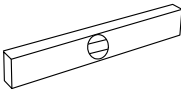
				
Safety Goggles	Drill	Silicone Adhesive	Jig Saw	Acetone
				
Phillips Screwdriver	Tape Measure	Pencil	Screwdriver	Level

NOTE: Specialized tools may be necessary to install Kraus Fireclay sinks with countertop materials other than wood, marble or granite.

Parts List

- Sink
- Strainer ST-4
- Cutting Board KCB-WS302SA

Dimensions

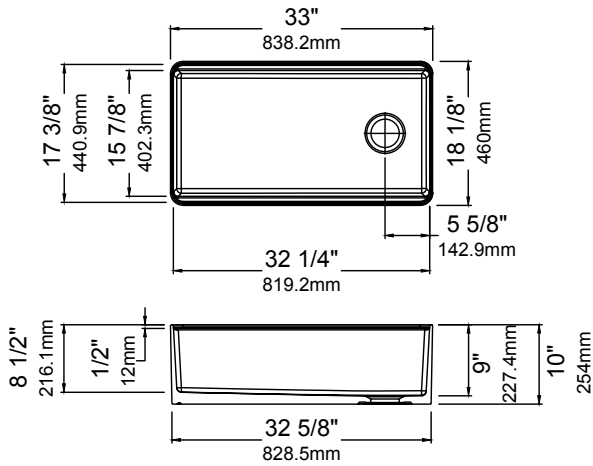

KFR4-33GWH
33" x 18 1/8" x 10"

1. Measure & Build Supports

- Measure the actual height of apron
- Build supports on inside of cabinet based on sink measurements

Installer Tip: Support options

- 1 1/4" Angle Irons
- (2) 2" x 4'
- 3/4" Plywood

NOTE: Due to the typical $\pm 3\text{mm}$ side wall variance in manufacturing, it is recommended that you design / modify the sink cabinet to match your clients individual sink(s) need.

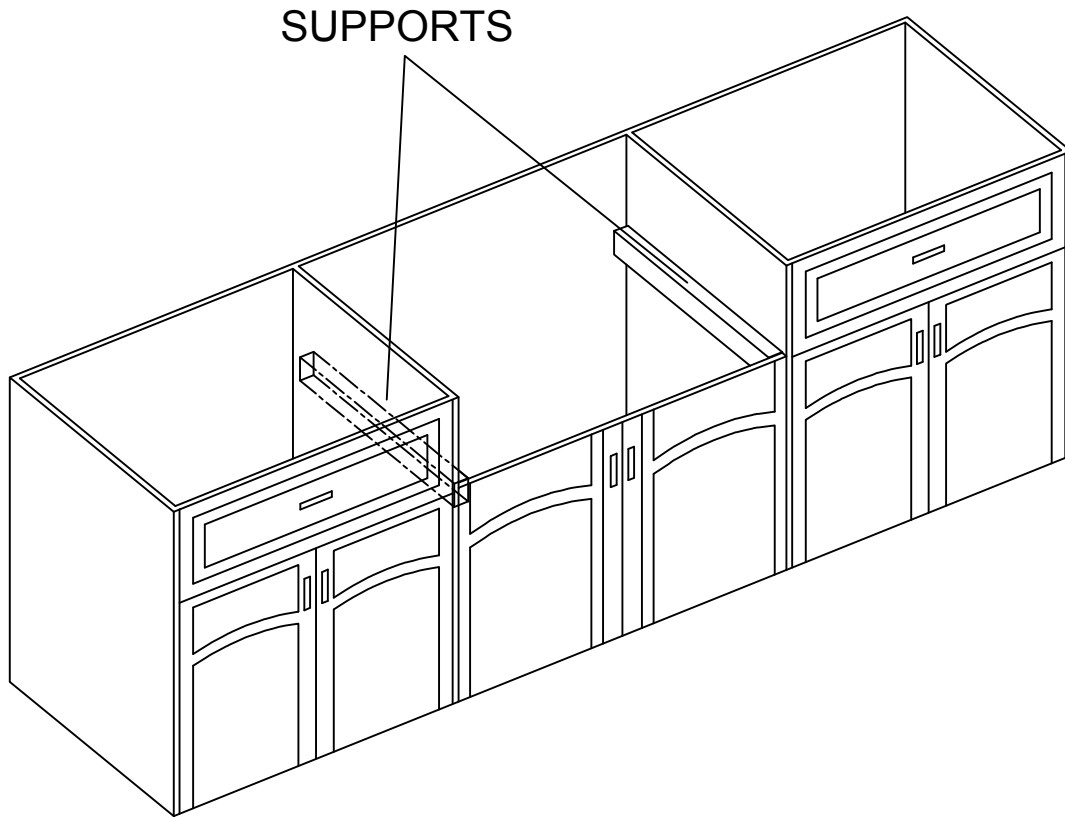

2. Cut Cabinet Front

- Measure height of apron front. Add $\frac{1}{16}$ " to the dimension when you mark base cabinet front cutout. Use jigsaw to cut.

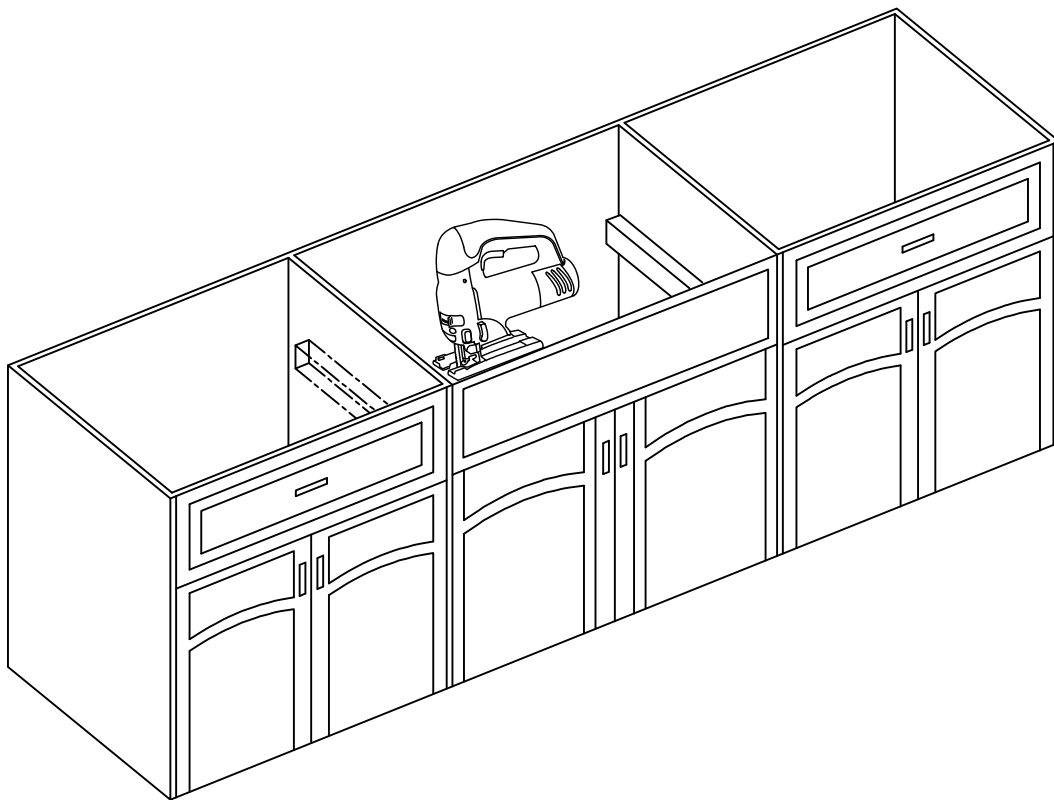

3. Install Sink

- Place sink in opening. The weight of sink should be sustained by the built supports.
- Make sure sink is leveled from front to back and side to side
- Uses silicone to fill in gaps where necessary

NOTE: This sink is reversible. Pick which apron you'd like facing forward before installing.

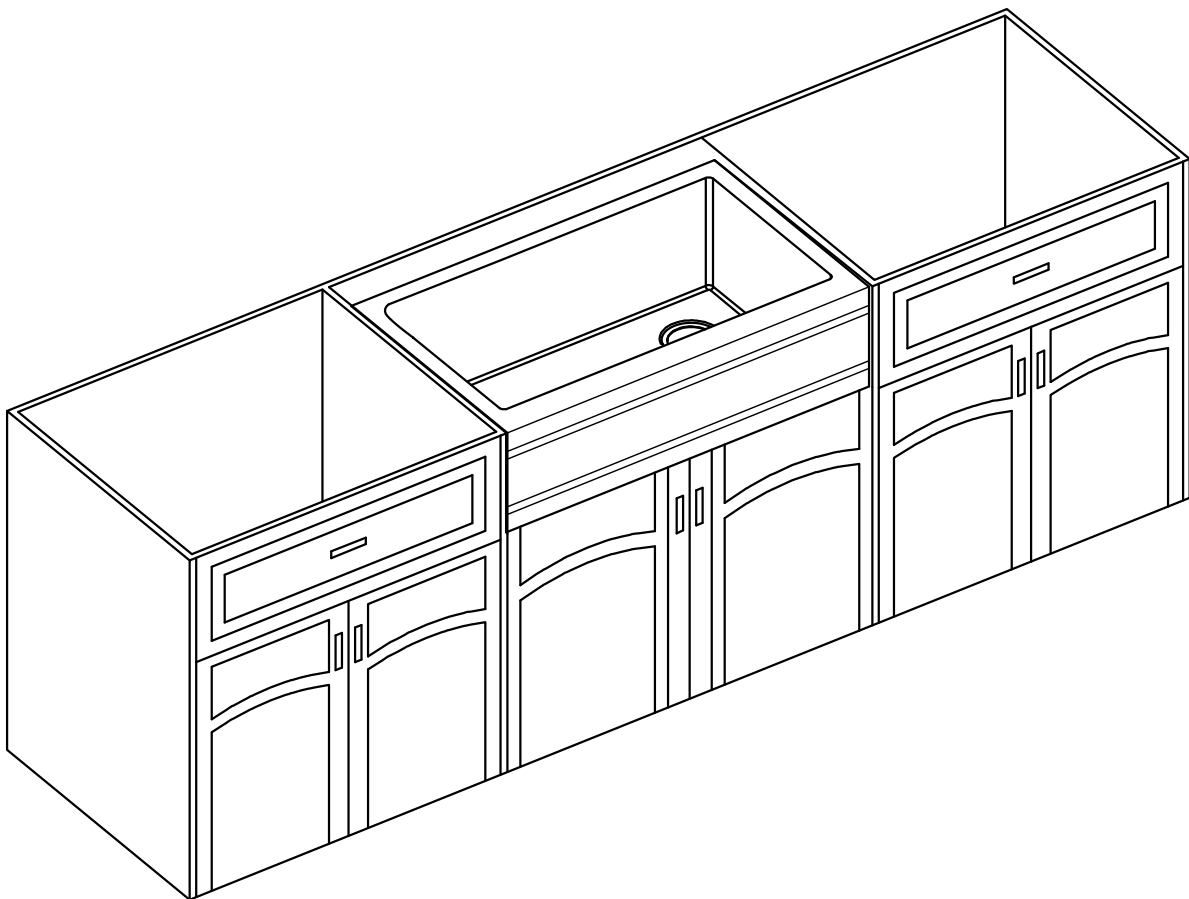

4. Cut Countertop

- Due to the custom nature of this type of installation, no cutout template is included.
- Kraus recommends providing the cabinet maker with the actual sink to be installed prior to the cabinet fabrication.
- It is recommended that the sink be installed with an approximately 1/8" positive reveal. It is further recommended that the installer(s) discuss this with the customer and agree that this finished appearance is the desired effect.

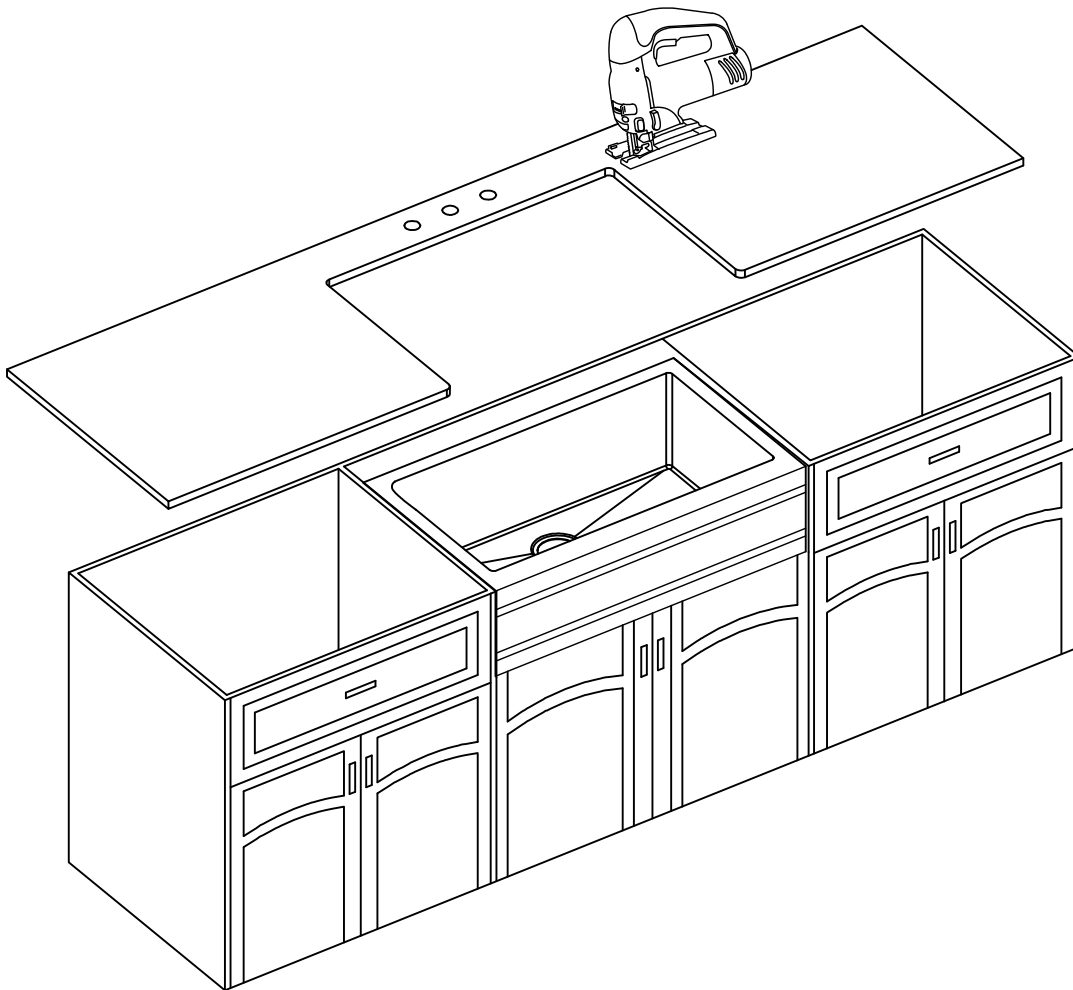

5. Install Countertop

- Use a bead of silicone (or preferred adhesive) around the rim of the sink. Check the alignment of the sink to the cutout in the countertop. Place countertop cutout hole over sink and press firmly.

Installer Tip: Use acetone or denatured alcohol to remove any excess sealant.

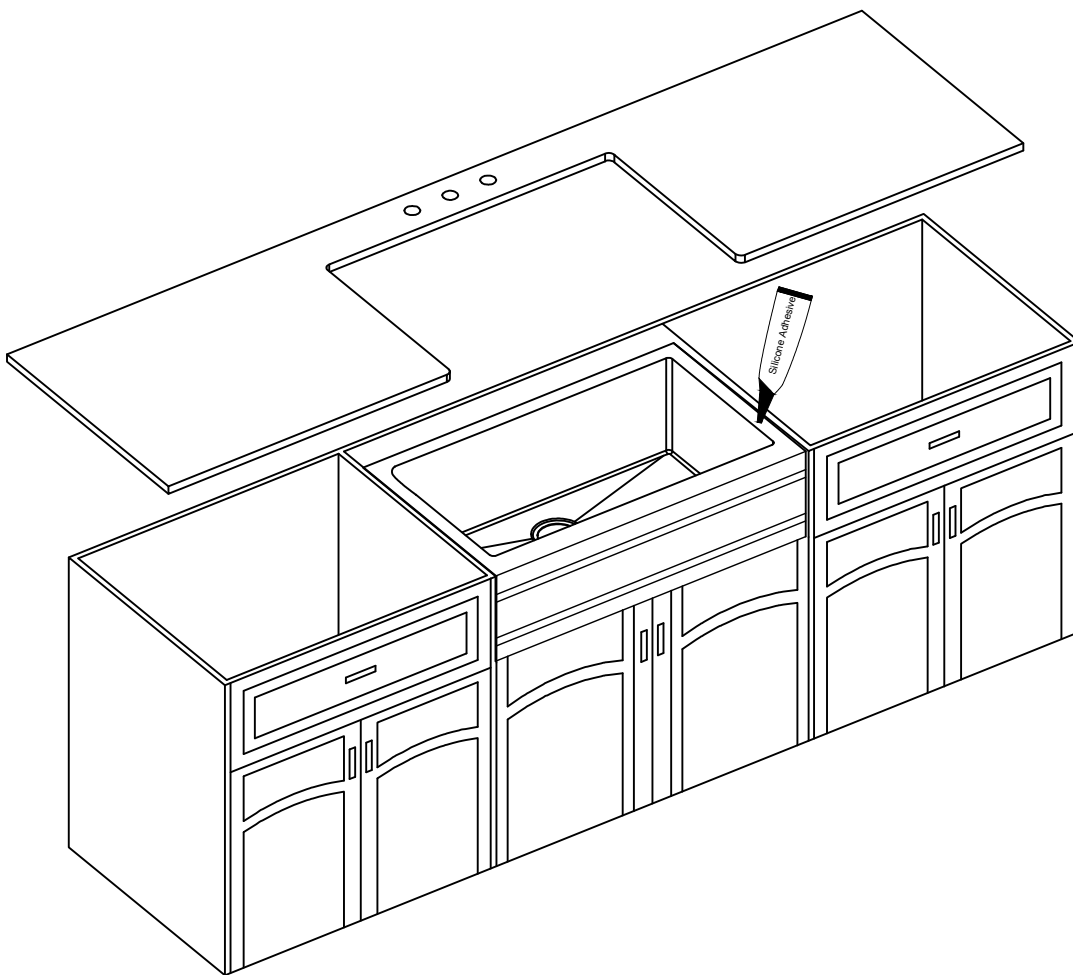

6. Installing Plumbing and Fixtures

- Connect drain, trap to drain and water supply connections to the faucet according to manufacturer's instruction.
- Run water into sink and check for leaks.

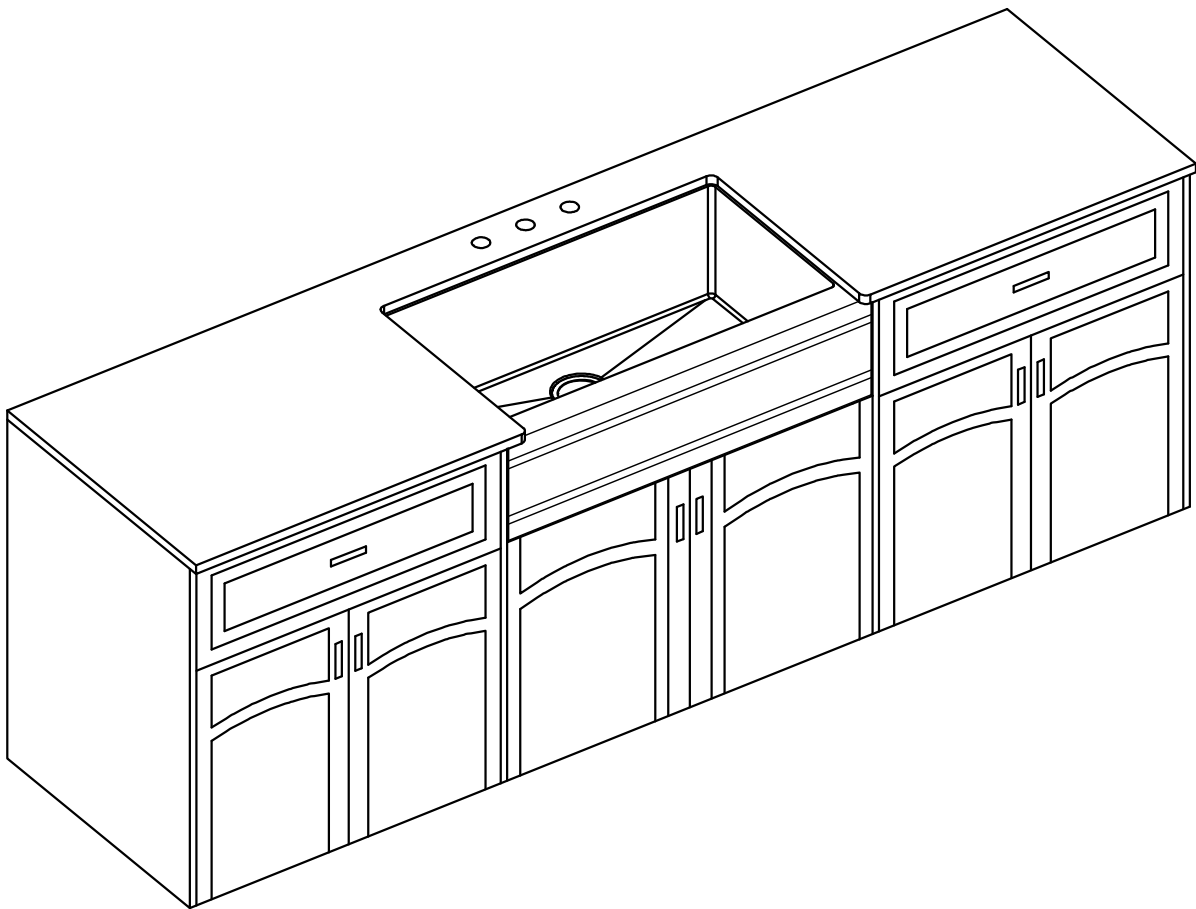

Codes/Standards Applicable:



Fireclay Kitchen Sink Warranty

Kraus products are manufactured and tested to the highest quality standards by Kraus USA Inc. ("Kraus").

Kraus extends this warranty to the original purchaser for personal household use of the "Fireclay Kitchen Sink" in its original location. The warranty is non-transferable.

Kraus warrants the structure and finish of the product to be free from defects in material and workmanship under normal usage for a period of five (5) years. The warranty commences from the initial date of purchase by the owner or trade professional, from an authorized Kraus dealer, through the five (5) year term of the original owner or end-user.

Any product reported to the authorized dealer or to Kraus as being defective within the warranty period will be repaired or replaced with a product of equal value at the option of Kraus. This warranty extends to the original owner or end-user, and is not transferable to a subsequent owner.

Restrictions

This warranty does not cover antediluvian, discontinued, or display products, whether such items are purchased at discount outlets, unauthorized dealers, and/or sold on clearance.

This warranty does not cover instances of negligence, misuse, abuse, improper installation, carelessness, accident, hard water or mineral deposits, exposure to corrosive materials, misapplication, damages caused by improper maintenance, alteration of the product, or failure to follow care or installation instructions enclosed with your product. Avoid using abrasive cleaners such as powders, bleach, ammonia, alcohol, or chlorine. Avoid using abrasive pads, steel wool, or wire brushes, as these will damage and wear down the finish.

This warranty does not apply to Products that have not been installed or operated in accordance with instructions supplied by Kraus and all applicable rules, regulations, and legislation pertaining to such installations.

This warranty does not apply unless the Kraus product is installed by a fully insured and licensed trade professional. Kraus insists that such professionals have experience in the installation of bathroom and kitchen manufactured goods.

This warranty does not cover labor charges or costs of removal and reinstallation of said product. This warranty does not allow recovery of incidental or consequential damages, such as loss of use, delay, property damage, or other consequential damages, and Kraus accepts no liability for such damages.

This warranty does not cover Marine or Outdoor Installation.

This warranty does not cover any free gifts included with purchase.

Except as otherwise provided above, Kraus makes no warranties, expressed or implied, including warranties of merchantability and fitness for a particular purpose, or compliance with any code.

Shipping charges will be covered for the first (1) year of the warranted replacement part or product (HI, AK, and Puerto Rico shipping charges may apply). International shipping fees are not included.

Commercial Warranty

Kraus extends the above warranty for a period of one (1) year to purchasers of products for industrial, commercial, and business use.

All incidental or consequential damages are specifically excluded. No additional warranties, express or implied, are given, including but not limited to any implied warranty of merchantability or fitness for a particular purpose.

Some states do not allow the exclusion or limitation of incidental or consequential damages or limitations on how long an implied warranty lasts, so the above limitations or exclusions may not apply to you.

This warranty gives you specific legal rights, and you may also have other rights which vary from state to state.

KRAUS USA has the right to change, modify, and/or update the warranty policy at any time. For the latest, most up to date comprehensive warranty, go to www.kraususa.com/warranty.

HELP LINE

Our customer service hours are Monday - Friday, 9am - 8pm EST.
Be sure to visit our website at www.kraususa.com.

If you are a HOMEOWNER, please contact a Kraus Customer Service Representative at:

Kraus USA, Inc.
12 Harbor Park Drive
Port Washington, NY 11050
Toll-Free : 800-775-0703
Customerservice@kraususa.com

If you are a PLUMBING CONTRACTOR OR TRADE PROFESSIONAL, please contact a Kraus Pro Representative at:

Kraus USA, Inc.
12 Harbor Park Drive
Port Washington, NY 11050
516-801-8955
Proservice@kraususa.com

If you are an AUTHORIZED PARTNER, please contact a Partner Support Representative at:

Kraus USA, Inc.
12 Harbor Park Drive
Port Washington, NY 11050
516-801-8954
Partnersupport@kraususa.com

In requesting warranty service, please be ready to provide:

1. Proof of purchase.
2. A description of the problem.

IMPORTANT

Register Your Kraus Product

Activate Your Warranty

Access Premium Customer Support

Get Product Information

REGISTER TODAY

<http://www.kraususa.com/registration>



Kräus[®]
www.kraususa.com