

Tools Required

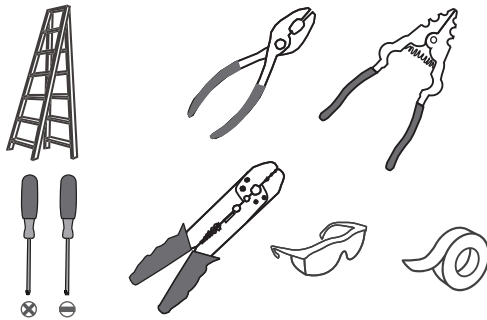

Light Source

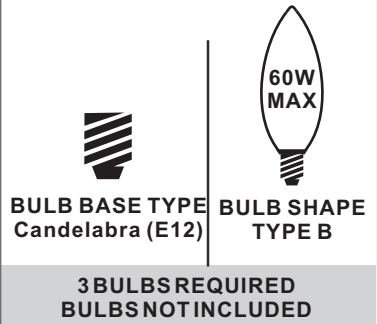

Warnings and Cautions

Turn off the electricity at the circuit breaker before installation. Consult a licensed electrician if in doubt about installation.

Turn off power to the fixture and allow the bulbs to cool before replacing.

Package Contents

Preparation: Identify and inspect all parts before beginning the installation.

Missing or damaged parts? Contact your original place of purchase.

PARTS BAG

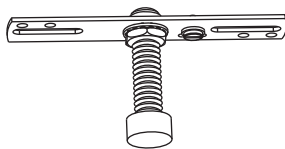

A Crossbar Assembly x 1



B Outlet Box Screw x 2



C Wire Connector x 3

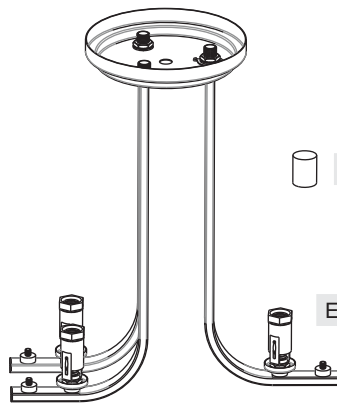

D Lock Ball x 3

E Fixture Body x 1

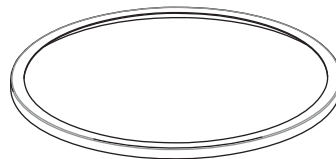

F Top Ring x 1

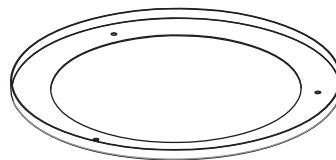

G Bottom Ring x 1

Note: Shade shape is for illustration purpose only. Your shade shape may vary from illustration.

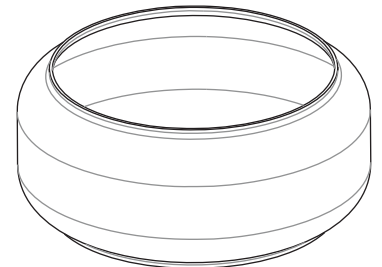

H Shade (Varies according to style purchased) x 1



I Candle Cover x 3

Table of Contents

| Unfold Arms | Crossbar Assembly | Bottom Ring | Shade & Top Ring | Wiring | Ceiling Canopy | Candle Covers & Bulbs |
|---------------|-------------------|---------------|------------------|---------------|----------------|-----------------------|
| | | | | | | |
| STEP 1 | STEP 2 | STEP 3 | STEP 4 | STEP 5 | STEP 6 | STEP 7 |

STEP 1

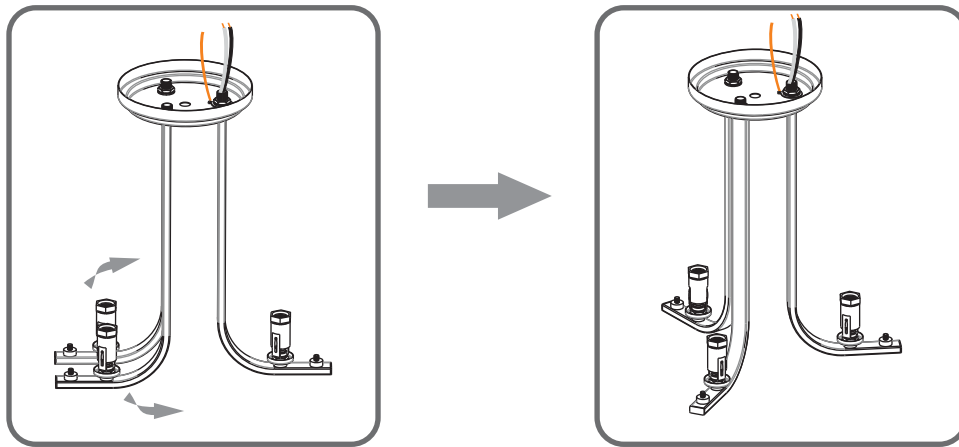

STEP 2

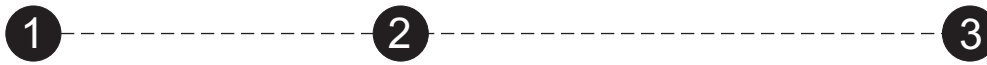

Step 1
Install crossbar assembly

Step 2 - 3
Test fitting ceiling canopy to nipple

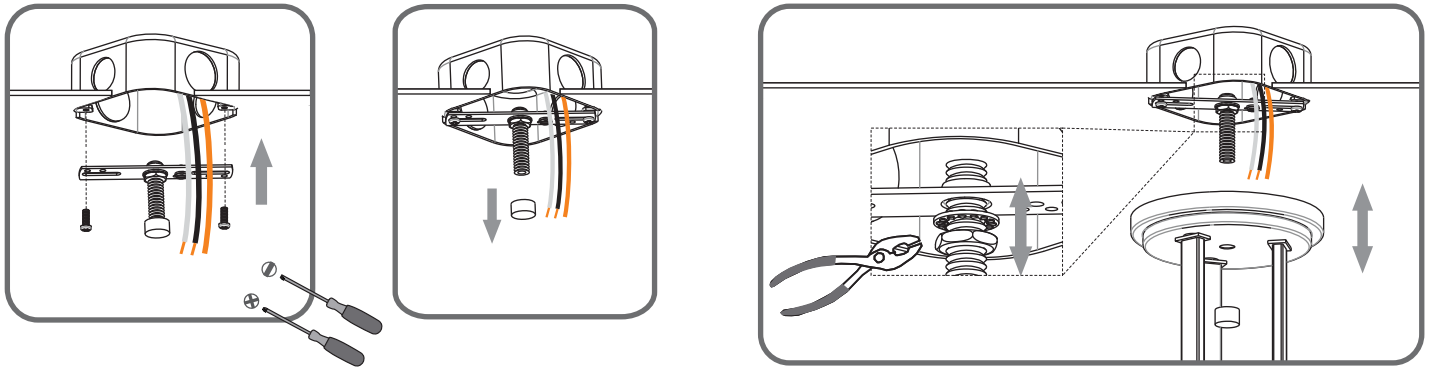

STEP 3

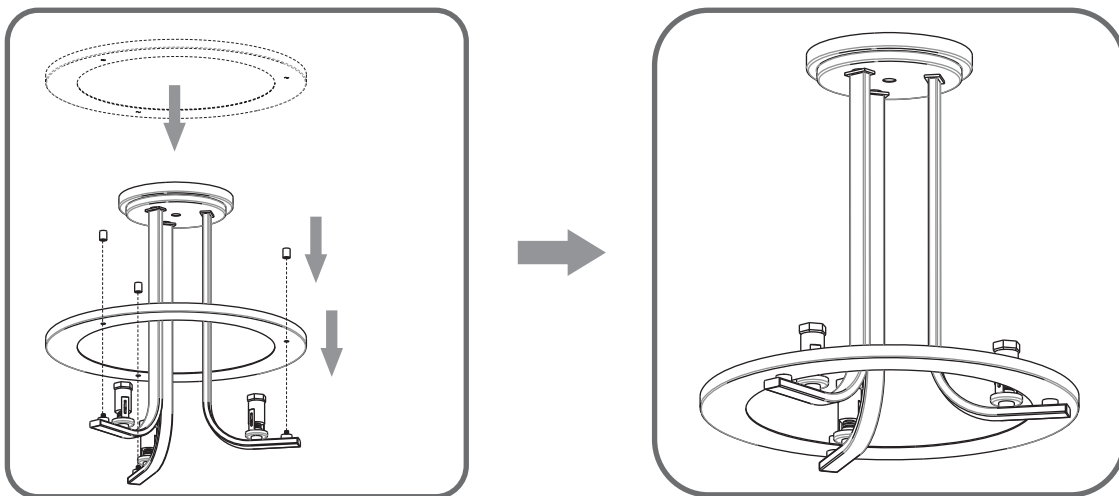

STEP 4

Note: Shade shape is for illustration purpose only. Your shade shape may vary from illustration.

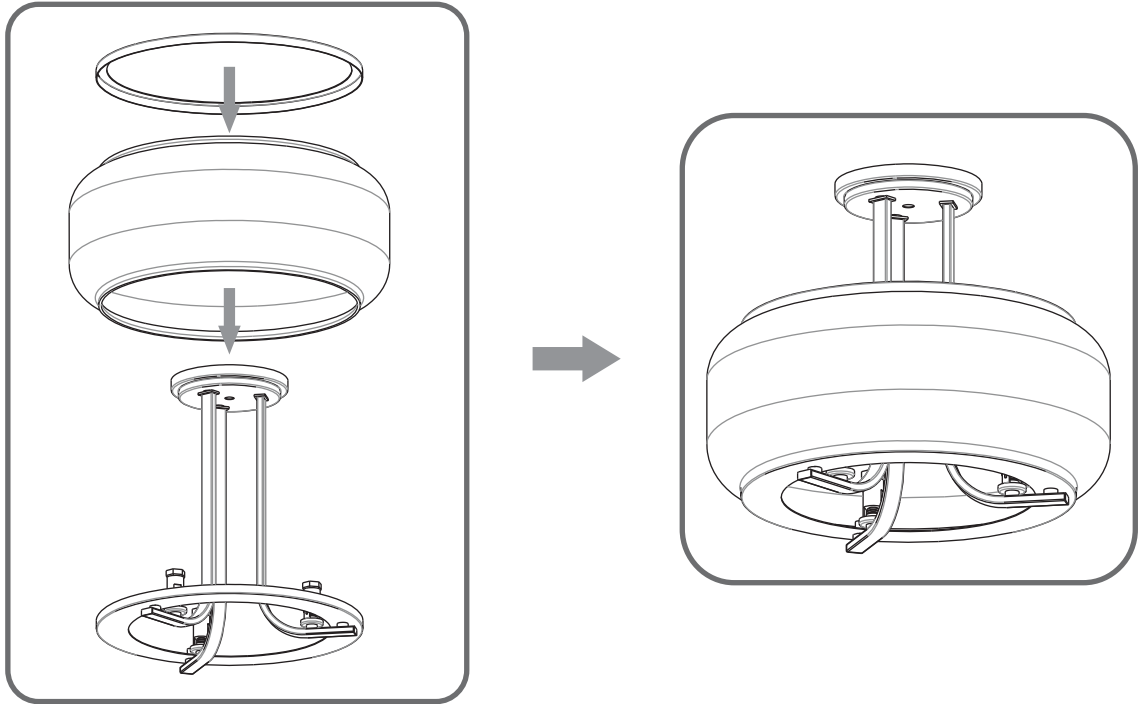

STEP 5

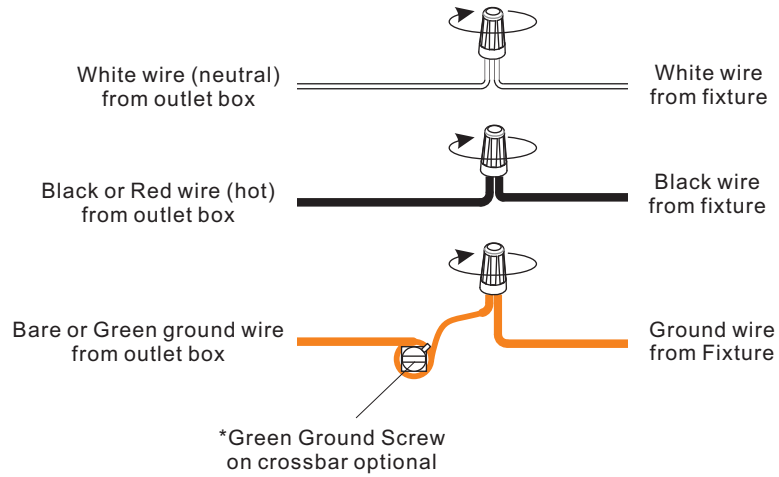

STEP 6

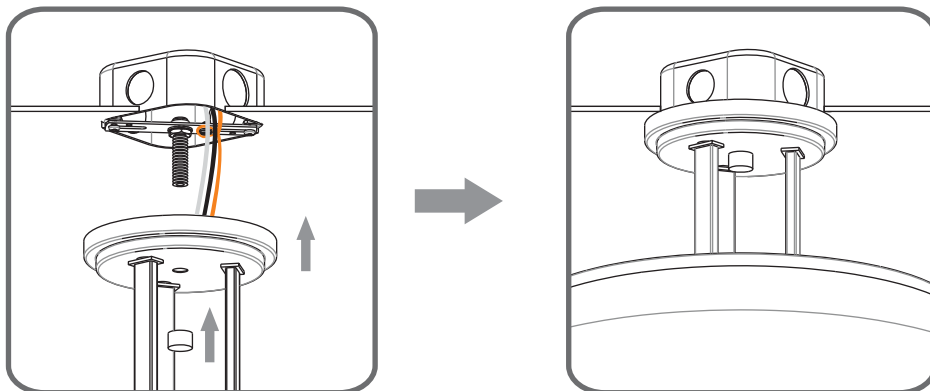

STEP 7

