

Tools Required

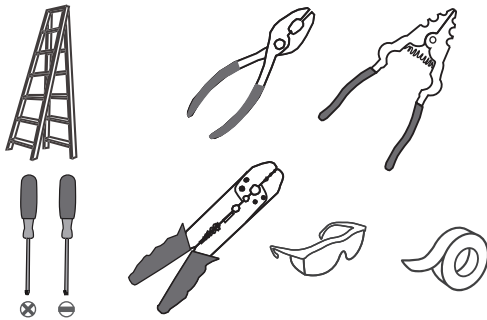

Light Source

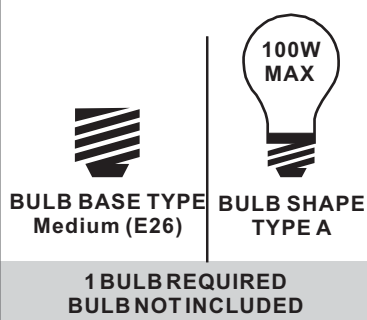

**Fixture Height Adjustable
10.25" to 46.25"**

Warnings and Cautions

Turn off the electricity at the circuit breaker before installation. Consult a licensed electrician if in doubt about installation.

Turn off power to the fixture and allow the bulbs to cool before replacing.

Package Contents

Preparation: Identify and inspect all parts before beginning the installation.

Missing or damaged parts? Contact your original place of purchase.

PARTS BAG

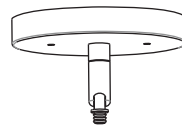
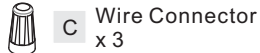
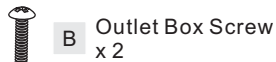
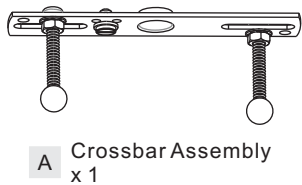

D Ceiling Canopy x 1

H Shade (Varies according to style purchased) x 1

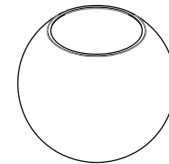
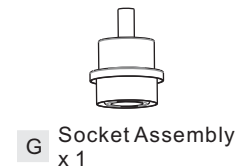

Note: Shade shape is for illustration purpose only. Your shade shape may vary from illustration.

Table of Contents

Crossbar Assembly

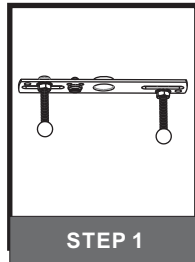

STEP 1

Downrod

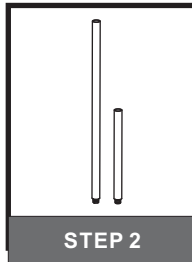

STEP 2

Wiring

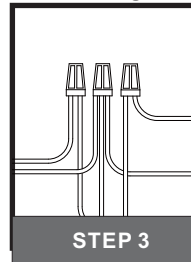

STEP 3

Ceiling Canopy

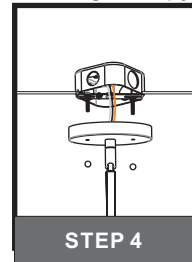

STEP 4

Shade&Bulb

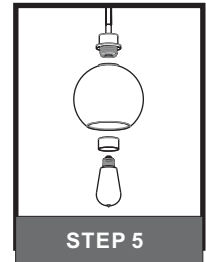

STEP 5

STEP 1

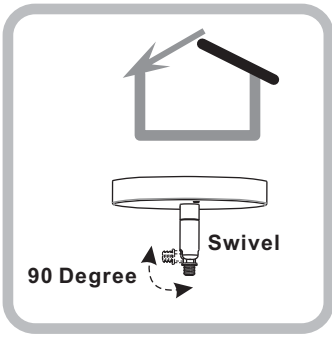

For angled ceilings,
Swivel opening towards wall.

1

Step 1
Install crossbar assembly

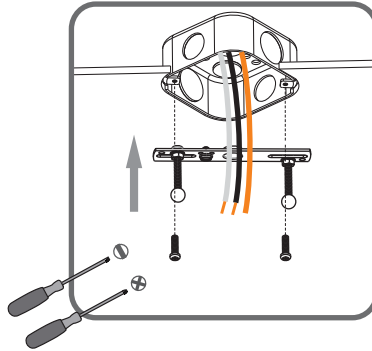

2

Step 2 - 3
Test fitting ceiling canopy to
mounting screws

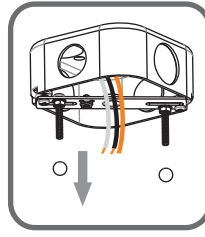

3

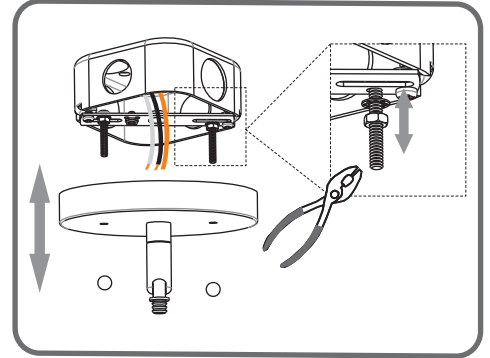

STEP 2

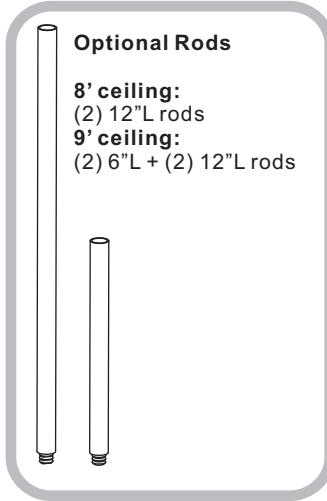

1

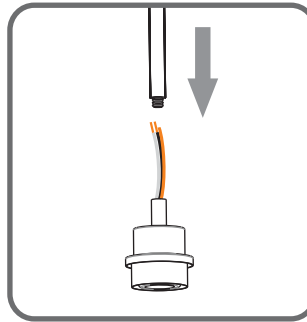

2

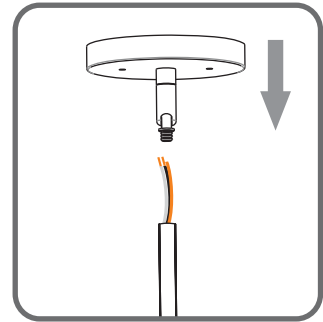

STEP 3

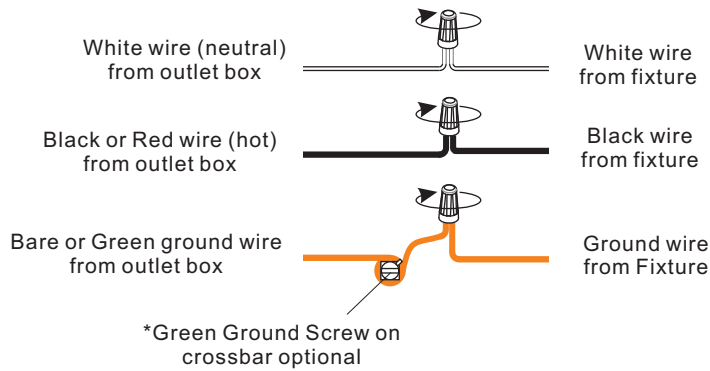

STEP 4

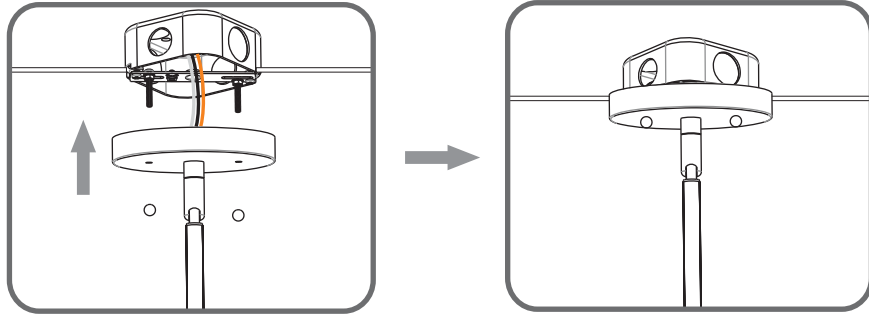

STEP 5

1

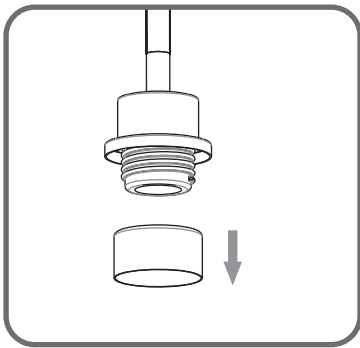

2

Note: Shade shape is for illustration purpose only. Your shade shape may vary from illustration.

