

CARE AND MAINTENANCE



Unplug lamps before using any cleaning solutions. Dust shades with a feather duster or with an appropriate vacuum-brush attachment. Wipe with a soft, dry cloth and clean lamp bases with the methods appropriate to the material. Avoid the use of chemicals and household cleaners as they may damage the finish.

NOTICE& IMPORTANT SAFETY INSTRUCTIONS

- * Please make sure that you have all parts indicated before you begin assembly of this item
- * This item should be assembled on a soft surface to prevent scratching the finish during assembly
- * To reduce the risk of fire, electrical shock or injury to persons or property, please follow the guideline below for safe use and installation
- *The external flexible cable or cord of this luminaire cannot be replaced;
If the cord is damaged, the luminaire shall be destroyed

**This portable lamp has a polarized plug (one blade is wider than the other) as a safety feature to reduce the risk of electric shock. this plug will fit in a polarized outlet only one way. if the plug does not fit fully in the outlet, reverse the plug, if it still does not fit, contact a qualified electrician. never use with an extension cord unless the plug can be fully inserted. do not attempt to defeat this safety feature.

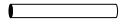
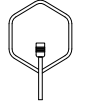
Part List and Hardware List

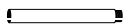
PIECE	DESCRIPTION	PICTURE	QUANTITY	PIECE	DESCRIPTION	PICTURE	QUANTITY
A	Bulb		1X	D	Lower Tube		1X
B	Lamp Body		1X	E	Base		1X
C	Tube with teeth		2X				



Model# FLL4014A
Product Dimensions: 13" X 9.5" X 57.75"H

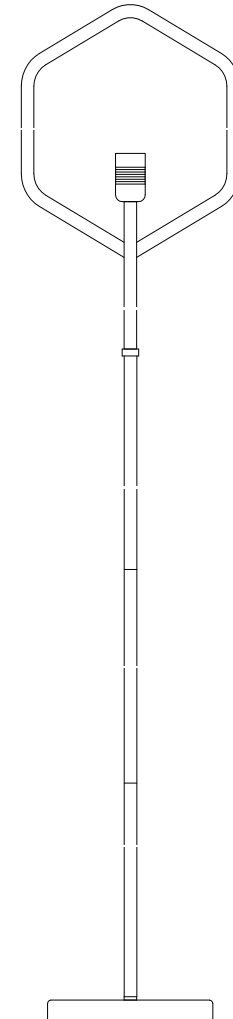

PREPARATION

Before beginning assembly of product, make sure all parts are present. Compare parts with package contents list and hardware contents list.

If any part is missing or damaged, do not attempt to assemble the product.

Estimated Assembly Time: 6 minutes.

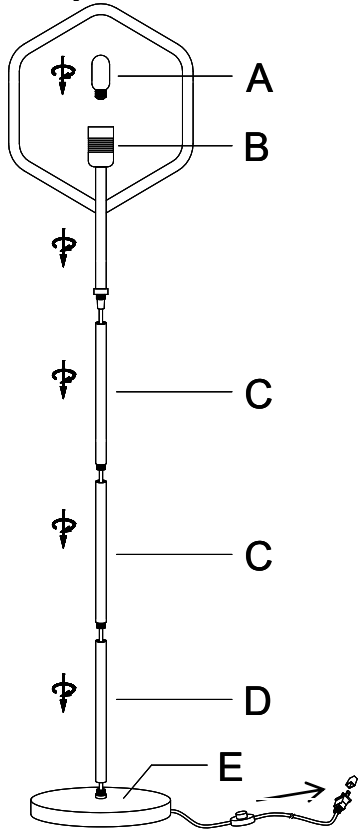

Step 1

Screw the bottom threaded portion of the Lower Tube (D) into the Base (E)

Insert the Tube with teeth(C) into the Lower tube(D)

Insert the Tube with teeth(C) into the Tube with teeth(C).

Insert the threaded portion of the Lamp body(B) into the Tube with teeth(C).

Pull power cord to connect the Lamp Body (B) to the Base (E).

Insert the Bulb(A) into the socket.

Be careful not to twist the power cord and tighten securely

**PLEASE USE TYPE "A" MAX 60-WATT OR EDISON BULB MAX 60-WATT
OR CFL MAX 13-WATT OR LED MAX 9-WATT
THERE IS 1PC 4-WATT EDISON BULB IN THE BOX.**

ENJOY YOUR LAMP