

Contents

| | |
|---|-----------|
| 1 Instructions | 7 |
| 1.1 Introduction | 7 |
| 1.2 This user's manual | 7 |
| 1.3 Intended use | 7 |
| 1.4 Manufacturer's liability | 8 |
| 1.5 Identification plate | 8 |
| 1.6 Disposal | 8 |
| 2 Description | 9 |
| 2.1 Product Description | 9 |
| 3 Use | 10 |
| 3.1 Before first use | 10 |
| 3.2 First use | 11 |
| 3.3 How to make espresso | 12 |
| 3.4 How to make cappuccino | 14 |
| 3.5 How to heat water | 15 |
| 3.6 Accessing the programming menus and changing the settings | 15 |
| 3.7 How to cool down the boiler | 18 |
| 4 Cleaning and maintenance | 19 |
| 4.1 Warnings | 19 |
| 4.2 Cleaning the body of the espresso machine | 19 |
| 4.3 Cleaning the parts of the espresso machine | 19 |
| 4.4 Descaling | 21 |
| 4.5 What to do if... | 22 |

Important Safeguards

WARNING: If the instructions contained in this manual are not followed precisely, fire or explosion may result causing property damage, personal injury or death.



READ AND SAVE THESE INSTRUCTIONS - Your safety and the safety of others are very important.

We have provided many important safety messages throughout this manual and on the appliance.

Read all the instructions before using the appliance and always obey all safety messages.



Important Safeguards



RECOGNIZE SAFETY INFORMATION

This is a safety alert symbol. This symbol alerts you to potential hazards that can result in severe personal injury or death.

UNDERSTAND SIGNAL WORDS

A signal word - DANGER, WARNING or CAUTION - is used with the safety alert symbol. DANGER denotes the most serious hazards. It means you could be killed or seriously injured if you do not immediately follow the instructions.

WARNING means you could be killed or seriously injured if the instructions are not followed. CAUTION indicates a potentially hazardous situation, which, if not avoided, could result in minor to moderate injury.

WARNING



- This appliance is intended for use in the home only.
- Use this appliance only for its intended purpose. The manufacturer cannot be held liable for damage caused by improper use of this appliance.
- This appliance complies with current safety regulations. Improper use of this appliance can result in personal injury and material damage.
- Read all the instructions before installing or using the appliance for the first time.
- Keep these operating instructions in a safe place and pass them on to any future user.

The safety messages will inform you of potential hazards, on how to avoid the risk of injury and what can occur if the instructions are not followed.

IMPORTANT: Observe all codes and ordinances in force.

WARNING: For your safety, the instructions contained in this manual must be followed to minimize the risk of fire or explosion and to prevent property damage, personal injury or death.

Do not store or use gasoline or other flammable vapors, liquids or materials near this or any other appliance.



NOTE: This appliance is NOT designed for installation in manufactured (mobile) homes or in recreational vehicles (RVs).

DO NOT install this appliance outdoors.

Important Safeguards



WARNING



To reduce the risk of fire, electrical shock, personal injury, or damage when using the appliance, follow basic safety precautions, including the following:

NE

Follow all safety precautions to ensure safe use of the appliance.

- Before using the appliance, read this user manual carefully.
- Do not use the appliance outdoors.
- This appliance is for household use only.
- Do not use the appliance for other than its intended use.
- Do not allow children to use the appliance.
- Children should not play with the appliance. Keep the appliance out of the reach of children.
- Turn off the appliance immediately after use.
- Do not leave the appliance unattended while it is running.
- Disconnect the appliance from the wall outlet before assembly, disassembly, cleaning and after each use.
- Let the appliance cool down before fitting or removing parts and before cleaning.
- To protect against fire, electrical shock and personal injury, do not immerse the appliance, the power cord or plug in water or any other liquid.
- Do not touch the appliance or the plug with wet hands.
- Never try to extinguish a flame/fire with water: turn off the appliance, unplug it from the outlet and cover the flame with a lid or a fire blanket.
- Do not use the appliance if the power cord or plug is damaged or if the appliance has been dropped or damaged in any way.
- Do not let the cord hang over the edge of a table or counter.
- If the power cord is damaged, contact the technical support service to get a replacement and to avoid possible hazards.
- Make sure the power cord does not come in contact with sharp edges.
- Do not pull on the cord to remove the plug from the socket.
- Do not place the appliance on or near switched-on gas or electric burners, inside an oven, or near heat sources.
- Do not touch hot surfaces. Use handles and knobs.
- Do not place the appliance near faucets or sinks.
- Never attempt to repair the appliance yourself or without the help of a qualified technician. Failing to do this will void the warranty.
- In case of malfunction, have the appliance repaired by a qualified technician.
- Do not make any changes to the appliance.



Important Safeguards

For this appliance

- Always unplug the espresso machine if left unattended, before assembly and disassembly of components and before cleaning.
- Unplug the espresso machine from the outlet when it is not in operation, before cleaning and in case of malfunction.
- Allow the espresso machine to cool before cleaning.
- Do not use the espresso machine without water in the tank or without the tank.
- Leave at least 1 inch of space between the espresso machine and any side or rear surface, and at least 6 inches of space above the espresso machine.
- Risk of scalding! The espresso machine generates heat and produces hot water and steam during operation.
- Risk of scalding! Do not touch the cup warmer tray during operation.
- Do not use the espresso machine in combination with parts or accessories from other manufacturers.
- Use only original spare parts from the manufacturer. The use of spare parts not recommended by the manufacturer may cause fire, electric shock or injury to persons.
- Place the espresso machine on a flat, dry surface.
- Avoid wetting or spraying liquid on the espresso machine. In case of contact with liquid, immediately unplug the cord from the electrical outlet and dry thoroughly: Risk of electric shock!
- Do not use abrasive cleaners or sharp objects to clean the espresso machine.
- A short power cord is provided to reduce risks resulting from becoming entangled in or tripping over a longer cord.
- Longer, detachable power supply cords or extension cords are available and may be used if care is exercised in their use.
- If an extension cord is used, the marked electrical rating should be at least as great as the electrical rating of the appliance. If the appliance is provided with 3-wire, grounding type cord, the extension should be a **GROUNDING TYPE 3 - WIRE CORD**. The longer cord should be arranged so that it will not drape over the counter-top or table top where it can be pulled on by children or tripped over.
- Your product is equipped with a polarized alternating current line plug (a plug having one blade wider than the other). This plug will fit into the power outlet only one way. This is a safety feature. If you are unable to insert the plug fully into the outlet, try reversing the plug. If the plug should still fail to fit, contact your electrician to replace your obsolete outlet. Do not defeat the safety purpose of the polarized plug.

SAVE THESE INSTRUCTIONS

Important Safeguards



NE

1 Instructions

1.1 Introduction

Key information for the user:

Warnings



General information about the user manual, safety and final disposal.

Description



Description of the appliance.

Use



Information on using the appliance.

Cleaning and maintenance



Information for proper cleaning and maintenance.



Safety warning



Information



Suggestion

1.2 This user's manual

This user's manual is an integral part of the appliance and must be kept intact and available to the user throughout its life cycle.

1.3 Intended use

- The appliance is for indoor use only.
- The appliance is intended solely for household-type use.
- The appliance can be used to prepare espresso and cappuccino using ground coffee or soft pods. Any other use is inappropriate. Do not use the appliance for purposes other than its intended use.



The California Safe Drinking Water and Toxic Enforcement Act requires the Governor of California to publish a list of substances known to the State of California to cause cancer, birth defects or other reproductive harm, and requires businesses to warn customers of potential exposure to such substances.



Warning

- This product contains a chemical known by the State of California to cause cancer, birth defects or other reproductive harm.
- This appliance can cause low-level exposure to some of the substances listed, including benzene, formaldehyde, carbon monoxide, toluene, and soot.



Important Safeguards

1.4 Manufacturer's liability

The manufacturer accepts no liability for damage to persons and property caused by:

- using the appliance in ways other than those provided;
- not reading the user's manual;
- tampering with any part of the appliance;
- using non-original parts;
- ignoring safety warnings.

1.5 Identification plate

The identification plate lists the technical data, serial number and brand name. The identification plate must never be removed.

1.6 Disposal



Power voltage Risk of electric shock

- Unplug the appliance.
- Unplug the cord from the wall outlet.
- **Old electrical equipment must not be disposed of with household waste!** In accordance with the law in force, electrical appliances at the end of their life should be taken to separate collection facilities for electrical and electronic waste. This is so that valuable materials from old appliances can be recycled and the environment can be protected. For more information, please contact your local authorities or recycling center employees.

Note that non-polluting and recyclable materials are used for packaging the appliance.

- Dispose of the packaging materials at appropriate differentiated waste collection centers.



Plastic packaging Risk of suffocation

- Do not leave the packaging or any part of it unattended.
- Do not allow children to play with the plastic packaging bags.



2 Description

2.1 Product Description

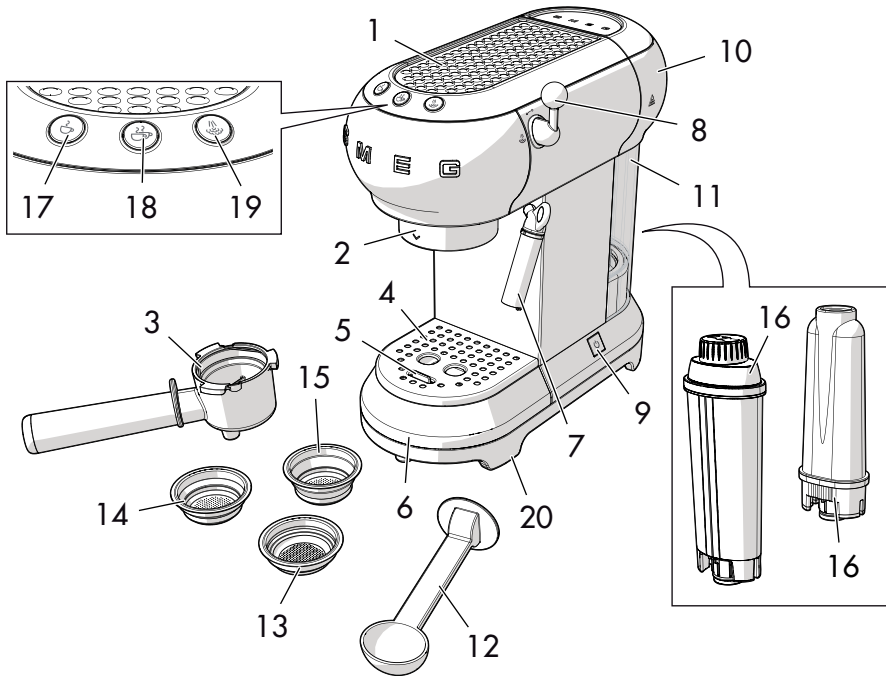

Model ECF01 - Espresso Machine

- | | |
|---|--|
| 1 Cup warmer tray | 11 Water tank (1 liter) |
| 2 Grouphead | 12 Measuring scoop/tamper |
| 3 Filter holder | 13 Soft pod filter basket |
| 4 Steel cup tray | 14 1-cup ground coffee filter basket |
| 5 Floater | 15 2-cup ground coffee filter basket |
| 6 Stainless steel drip tray | 16 Water softener filter (optional) |
| 7 Hot water and steam wand/Cappuccino frother | 17 1-cup coffee button (white light) |
| 8 Steam valve | 18 2-cup coffee button (white light) |
| 9 ON/OFF switch | 19 Steam button (white light)/Descaler button (orange light) |
| 10 Water tank cover | 20 Non-slip feet |



3 Use

3.1 Before first use

1. Remove any labels and stickers from the espresso machine.
2. Thoroughly wash and dry the espresso machine's parts (see "4 Cleaning and maintenance").
3. Remove the cover (1) by pulling it upwards and then pull out the tank (2).

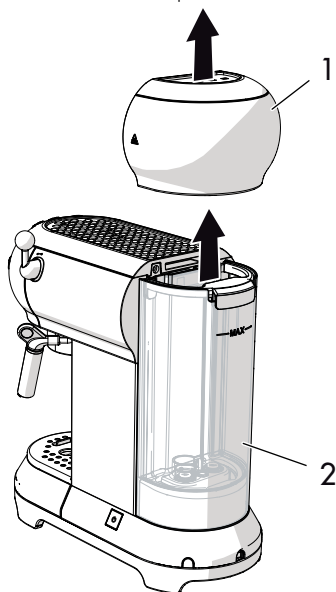

4. Fill the tank (2) with fresh, clean water directly from the faucet or by using a pitcher, being careful not to exceed the maximum level indicated on the tank.

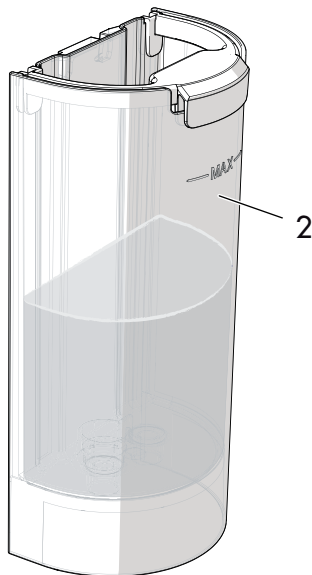

Risk of accident

- Do not operate the espresso machine without water in the tank or without the tank in place.



The parts that may come into contact with food are made of materials that comply with all legal provisions in force.



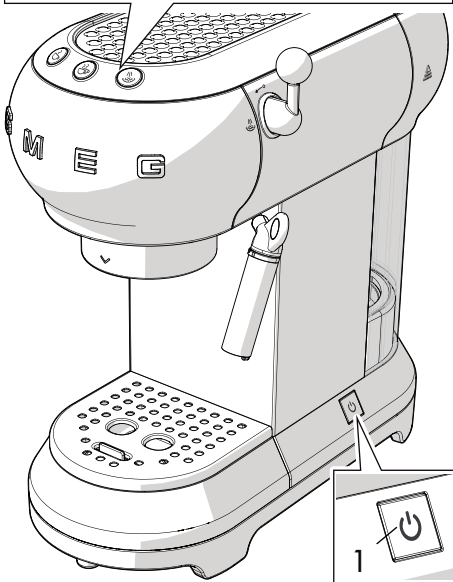
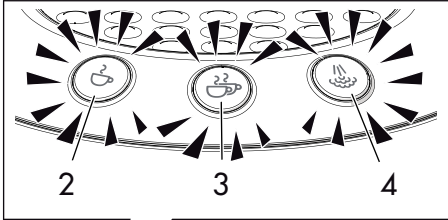

3.2 First use

1. Turn on the espresso machine using the ON/OFF switch (1): the lights of the three buttons (2), (3) and (4) will flash in sequence.



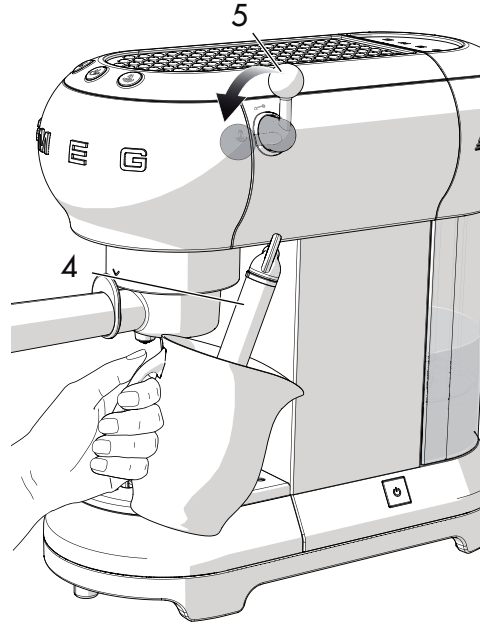

2. Lights (2) and (3) will flash to indicate that the machine is reaching the pre-set temperature. The espresso machine is ready for use as soon as the lights stop flashing.

3. Place a container under the hot water/steam wand (4).
4. Turn the steam valve (5) to the  position and dispense 1/2 cup of water.
5. Turn the steam valve (5) back to the  position.





i Make 4-5 espressos or 4-5 cappuccinos to obtain a satisfactory result.

6. Attach the filter holder by aligning the handle with  and turning it to the right to the  position.
7. To rinse the machine's internal circuits, place a container under the coffee spout and press the  button.
8. Repeat this procedure 5 times.



Then proceed with rinsing the “steam” circuit:

9. Place a container under the hot water spout and turn the steam valve to the  position. Hot water is delivered.
10. When the appliance automatically stops the hot water delivery, turn the steam valve back to the  position.
11. Repeat this procedure 1 more time (if necessary, refill the tank).

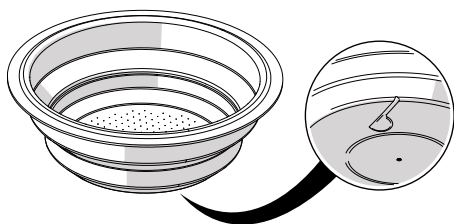

Filters

The coffee machine comes with three filters: a one-cup filter, a two-cup filter, and a soft pod filter. Below each filter you will find the corresponding symbol.



3.3 How to make espresso

Ground coffee:

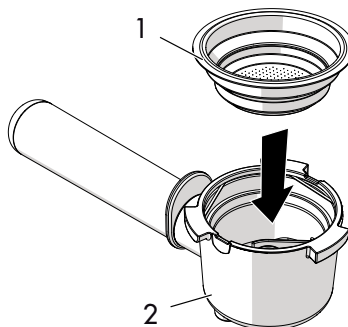

1. Place the ground coffee filter basket (1) in the filter holder (2), choosing the one-cup  or the two-cup  basket.

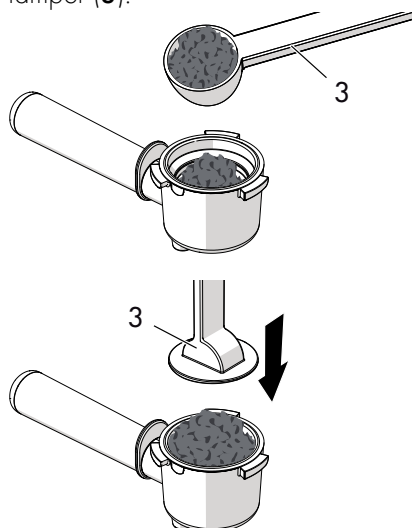

2. Tamp the ground coffee down using the tamper (3).





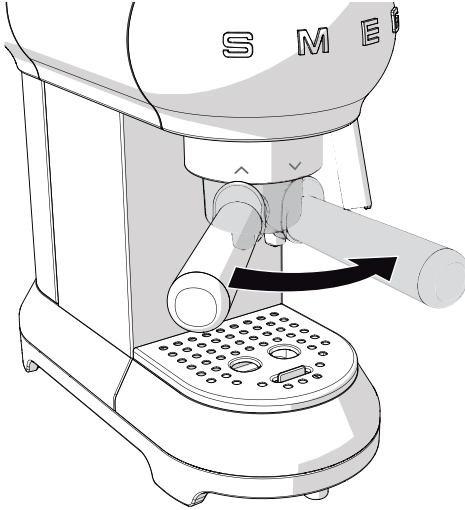

3. Wipe off any excess ground coffee from the edge of the filter holder. Attach the filter holder by aligning the handle with  and turning it to the right to the  position.



- For one cup, fill the filter basket with one level scoop of coffee (about 1 tablespoon.)
- For two cups, fill the filter basket with two scoops of coffee.
- For a stronger coffee, tamp the ground coffee hard with the tamper.
- For a weaker coffee, use the tamper to tamp the ground coffee lightly.

4. Place the cup or cups under the filter holder spouts and press the coffee button  or .

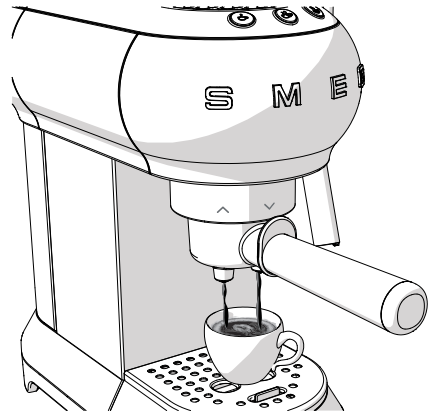

Risk of scalding

- To avoid any splashing, do not detach the filter holder while coffee is being dispensed. Wait a few seconds for the process to finish.



After the machine has not been used for a while (more than 30 minutes) it is normal for the first cups of coffee not to be at the right temperature.

The recommendations for obtaining a hot coffee immediately are shown in section "4.5 What to do if..."



Use

Coffee soft pods:

1. Insert the coffee soft pod filter basket  in the filter holder.
2. Insert the soft pod in the filter holder trying to center it as much as possible.
3. Proceed in the same way as with ground coffee.





Risk of scalding

- To avoid any splashing, do not detach the filter holder while coffee is being dispensed. Wait a few seconds for the process to finish.
- 
- The process can be interrupted at any time by pressing the coffee button.
 - To increase the amount of coffee in the cup, hold down the coffee button.

3.4 How to make cappuccino

1. Make an espresso in a large cup.
2. Press the  button: the light will flash.
3. Fill a container with 1/2 cup cold, partially skimmed milk for each cappuccino you want to make.

4. When the  light stops flashing, place an empty container under the cappuccino frother (1) and turn the steam valve (2) to the  position to drain any water present and then close the valve.
5. Place the container with the milk under the cappuccino frother (1), immersing the cappuccino frother a few millimeters below the surface. Turn the steam valve (2) to the  position and slowly move the container up and down to obtain a creamier foam.

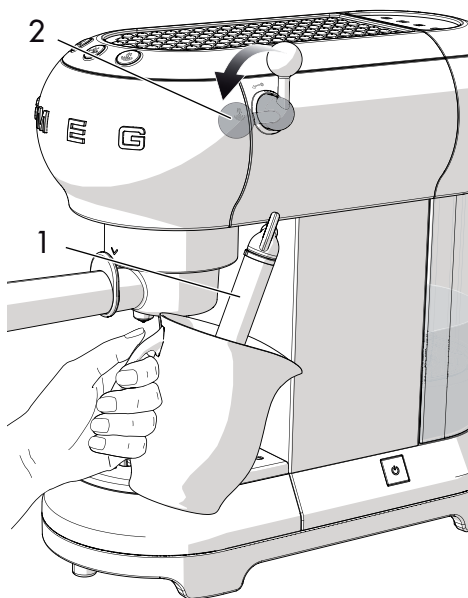



6. Once the volume of the milk has doubled, dip the cappuccino frother deep into the milk and heat to 140°F (60°C). Stop the frothing process by turning the steam valve clockwise.
7. Pour the milk into the cups with the espresso.



- To make more than one cappuccino, first prepare all the espresso and then froth the milk for all the cappuccinos.
- For hygiene reasons, it is recommended to clean the cappuccino frother after use.
- Clean out the milk residue by opening the steam valve to let out the steam.
- Release the steam for only a maximum of 60 seconds.

3.5 How to heat water

1. Turn the machine on using the ON/OFF switch.
2. Place a container under the cappuccino frother.
3. Turn the steam valve to the  position to let the hot water out.



- Release the steam for only a maximum of 60 seconds.

3.6 Accessing the programming menus and changing the settings









1. Make sure that the machine is ready to use and hold the  button for 10 seconds until the three buttons start flashing: the machine will enter programming mode.
2. Program the machine settings to your own needs.
3. To exit the menu, simply do not press any button for 15 seconds.







Use

Setting the coffee temperature



1. Access the programming menu.
2. Press the  button to select the temperature of the coffee. The lights of the current setting will turn on:

| Lights | Temperature setting |
|--|---------------------|
|    | Low |
|    | Medium |
|    | High |

3. The lights will start flashing in sequence.
4. Press the button corresponding to the desired temperature: low , medium  or high .
5. The  button will flash to indicate the selection has been saved.

Setting the amount of coffee









To change the quantity of coffee dispensed by the machine:

1. Place one or two cups under the filter holder spouts.
2. Press the button for one cup  or two cups  and hold it down.
3. The machine will start dispensing coffee.



4. Release the button as soon as you reach the desired amount of coffee.
5. The light will flash to indicate that the selected quantity has been saved.

Setting the water hardness

1. Access the programming menu.
2. Press the  button to select the water hardness. The lights of the current setting will turn on:

| Lights | Water setting |
|---|---------------|
|    | Soft |
|    | Medium |
|    | Hard |

3. The lights will start flashing in sequence.
4. Press the button corresponding to the water hardness:

|  soft |  medium |  hard |
|--|--|--|
| <10° dH | 10° dH - 20° dH | > 20° dH |
| <18° fH | 18° fH - 36° fH | > 36° fH |
| < 180 mg/l CaCo3 | 180-300 mg/l CaCo3 | 360 mg/l CaCo3 |

5. The  button will flash to indicate the selection has been saved.















Setting the auto shut-off time

For energy saving reasons, the espresso machine is equipped with an auto shut-off feature that activates when the machine has been left on for a long time.

To set the auto shut-off time:



1. Access the programming menu.
2. Press the  button to select the auto shut-off time. The lights of the current setting will turn on:

| Lights | Time setting |
|--|--------------|
|    | 9 minutes |
|    | 30 minutes |
|    | 3 hours |

3. The lights will start flashing in sequence.
4. Press the button corresponding to the time you want to set, choosing from 9 minutes , 30 minutes  or 3 hours .
5. The  button will flash to indicate the selection has been saved.

Restoring the factory settings

To restore factory settings:

1. Access the programming menu.
2. Turn the steam valve to the  position.
3. Press the  button: the three lights will blink to indicate that the original settings have been restored.
4. Turn the steam valve back to the  position.



3.7 How to cool down the boiler

The boiler must be cooled down if you want to make coffee immediately after frothing milk for cappuccino.

If the boiler is not cooled down, the coffee will be burned.

1. Place a container under the cappuccino frother and open the steam valve to dispense hot water.

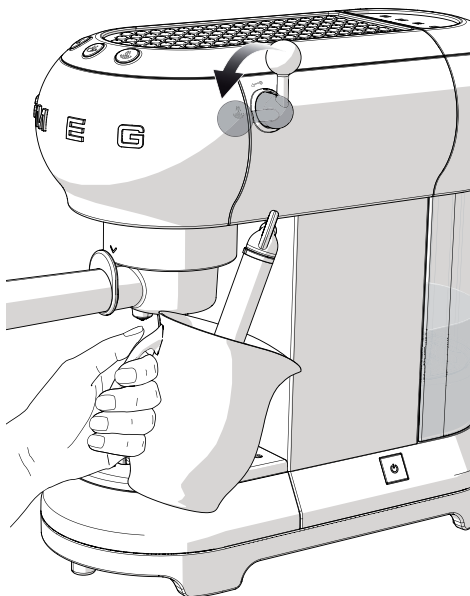

2. The hot water will stop coming out as soon as the machine has cooled down.
3. Close the steam valve and proceed with making the coffee.



4 Cleaning and maintenance

4.1 Warnings



Misuse
Risk of electric shock

- Unplug the espresso machine before cleaning.
- Do not immerse the espresso machine in water or other liquids.
- Allow the espresso machine to cool before cleaning.



Misuse
Risk of damage to surfaces

- Do not use steam jets to clean the espresso maker.
- Do not use cleaning products containing chlorine, ammonia or bleach on parts with metallic surface finishes (e.g. anodizing, nickel or chrome plating).
- Do not use abrasive or corrosive detergents (e.g. powders, stain removers and metal scouring pads).
- Do not use rough or abrasive materials or sharp metal scrapers.

4.2 Cleaning the body of the espresso machine

To maintain the outer surfaces, you must clean them regularly after each use after letting them cool down. Clean with a soft, damp cloth.

4.3 Cleaning the parts of the espresso machine

Cleaning the drip tray

The drip tray is fitted with a red floater (1) that protrudes from the cup tray as soon as the maximum level of liquid is exceeded.

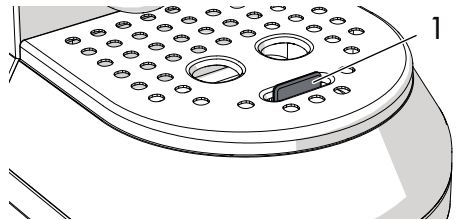

1. Remove the cup tray (2) and then the drip tray (3) to empty it.

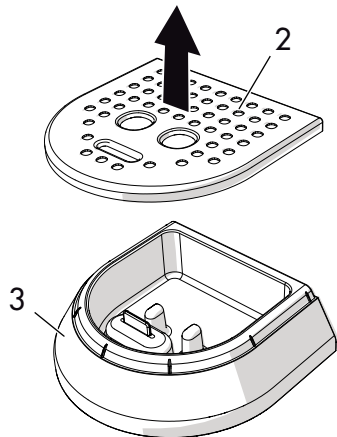

2. Clean the tray with a cloth and put it back in place with the cup tray.

Cleaning the filter baskets

Clean the filter baskets regularly under running water. If the holes are clogged, clean them with a pin or a brush.



Cleaning and maintenance

Cleaning the cappuccino frother

Clean the cappuccino frother immediately after use.

1. Turn the steam valve to release a little steam and to clean out the milk remaining inside it.
2. Switch off the espresso machine using the **ON/OFF** switch.
3. Hold the tube of the cappuccino frother (1) with one hand and with the other turn the cappuccino frother (2) counterclockwise and slide it down.

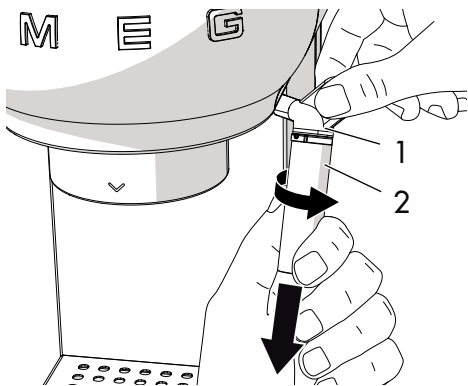

4. Remove the rubber nozzle (3) from the frother tube by pulling down on it.

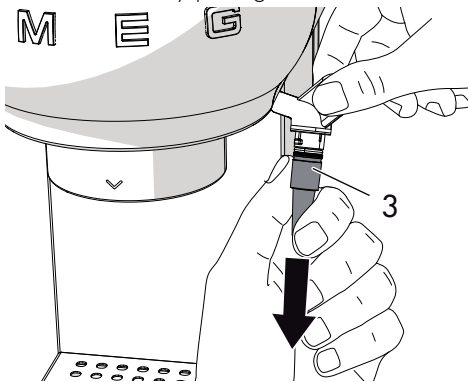

5. Wash the cappuccino frother and the nozzle with warm water.
6. Check that the hole (4) is not obstructed.

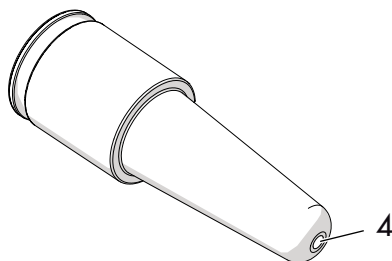

7. Insert the nozzle (3) in the cappuccino frother tube (1) and reposition the cappuccino frother (2) by sliding it upwards and turning it counterclockwise.
8. Put the cappuccino frother back together by following the cleaning instructions in reverse order.

Cleaning the grouphead

The grouphead should be rinsed out after every 200 coffees by flushing about 2 cups of water through it. To do this, press the coffee button without loading ground coffee or a soft pod.







Cleaning the water tank





Clean the water tank about once a month with a damp cloth and mild detergent.



4.4 Descaling

The espresso machine should be descaled when the  button lights up orange.

1. Fill the water tank with a solution of water and descaling solution in the amounts recommended by the manufacturer.
2. Press the **ON/OFF** switch.
3. Remove the filter holder and place a container under the cappuccino frother.
4. Wait until the  or  lights stop flashing.
5. Hold down the  button for 10 seconds until the three buttons begin to blink in sequence.
6. Turn the steam valve to the  position.
7. Press  to start the descaling process.
8. The descaling cycle will automatically perform a series of rinses to remove limescale from the espresso machine.
9. When the orange indicator light  flashes, it means the descaling cycle has been interrupted.
10. Remove the water tank, empty it and rinse it.
11. Fill the tank up with water to the maximum level and put it back in place.

12. Place an empty container under the cappuccino frother and check that the steam valve is in the  position. Then, press the  button to start the rinse cycle.
13. When the water tank is empty, it is necessary to perform a new rinse cycle, following steps 10, 11 and 12.
14. When the water tank is empty, the orange indicator light  turns off to indicate that descaling has finished.
15. Make sure that the steam valve is in the closed position .



Risk of injury

- Descaler contains acids which may irritate the skin and eyes.
- Carefully follow the manufacturer's instructions and safety warnings on the packaging in the event of contact with the skin or eyes.
- Use a descaling solution recommended by Smeg to avoid damage to the espresso machine.

Descaling and rinsing the grouphead

During the descaling cycle, close the steam valve from time to time to make the descaling solution flow out of the grouphead.

During the rinse cycle, close the steam valve from time to time to rinse the grouphead.



Cleaning and maintenance

4.5 What to do if...

| Problem | Possible cause | Solution |
|---|---|--|
| The coffee does not come out | No water in the tank. | Fill the tank. |
| | The filter holes are blocked. | Clean the filter basket by using a brush or a pin. |
| | The tank is not inserted correctly. | Insert the tank correctly. |
| The coffee drips from the filter holder and not from the spouts | Presence of limescale. | Run the descaling cycle. |
| | The filter holder is not attached properly or is dirty. | Attach the filter holder and turn it until it stops. Clean the filter holder. |
| | The grouphead gasket is worn. | Have it replaced at an authorized service center. |
| | The spout holes are clogged. | Clean the spout holes. |





Cleaning and maintenance



| Problem | Possible cause | Solution |
|--|--|---|
| The filter holder does not latch into the espresso machine | The filter basket is too full. | Use the measuring scoop provided and use the correct filter basket. |
| The espresso machine does not work and all the lights are blinking | Possible fault. | Unplug the espresso machine and contact an authorized service center. |
| The espresso's crema is clear and comes out too quickly from the spout | The ground coffee has not been tamped enough. | Tamp the coffee more. |
| | There is too little ground coffee. | Increase the amount. |
| | The coffee grind is too coarse. | Only use ground coffee for espresso machines. |
| | The quality of the ground coffee is not correct. | Change the type of ground coffee. |



Cleaning and maintenance

| Problem | Possible cause | Solution |
|--|--|---|
| The espresso's crema is dark and comes out too slowly from the spout | The ground coffee has been tamped too hard. | Tamp the coffee less. |
| | There is too much ground coffee. | Decrease the amount. |
| | The grouphead or the filter basket is clogged. | Clean the outlet and the filter basket. |
| The  and  lights flash for a few seconds | The coffee grind is too fine. | Only use ground coffee for espresso machines. |
| | Presence of limescale. | Run the descaling cycle. |
| | Steam valve open. | Close the steam valve. |
| The  and  lights flash for a few seconds | Boiler temperature is too high. | Cool down the boiler. |
| | Presence of limescale. | Run the descaling cycle. |

Cleaning and maintenance



| Problem | Possible cause | Solution |
|---------|----------------|----------|
|---------|----------------|----------|

NE

No water in the tank.

Fill the tank.

The grouphead or the filter basket is clogged.

Clean the grouphead and the filter.

The tank is not inserted correctly.

Insert the tank correctly.

Coffee is not hot

Machine not used for a long time.

Increase the temperature of the coffee from the programming menu following the instructions in section "Setting the coffee temperature".

Dispense hot water into the cup in which the coffee will be prepared in order to heat the cup.



If the problem has not been resolved or there are other types of faults, contact your local authorized service center.