

SPEAKMAN®

Neo™ Universal Trim

CPT-1000-UNI

SPECIFICATION

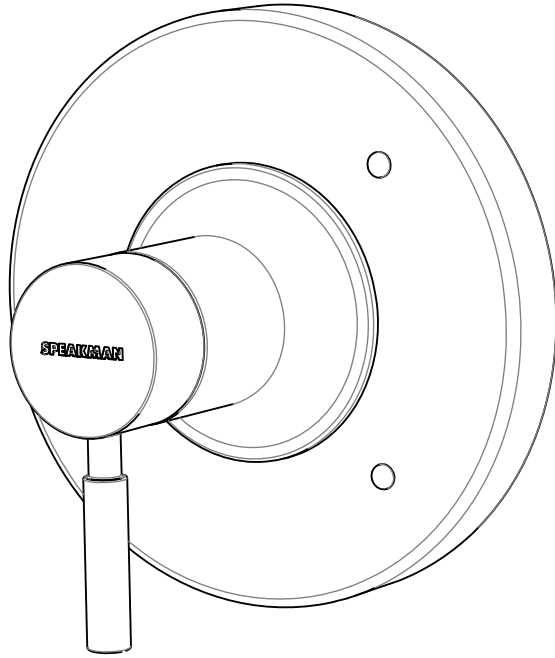

FEATURES:

- Metal valve handle
- Round ABS wall plate
- Configurable hot and cold indicators
- Includes all mounting hardware

COMPLIANCE:

- Meets ASME A112.18.1/CSA B125.1

FINISH:

ADD SUFFIX TO MODEL #

- Chrome (standard)
- Brushed Nickel -BN

WARRANTY:

- 5 year limited

Compatible valve model retrofits include

DELTA® MultiChoice®

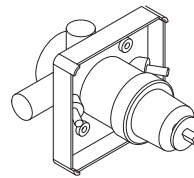

R10000-UNBX
R10000-UNBXHF
R10000-UNWS
R10000-UN
R10000-UNWSHF

KOHLER® Rite-Temp®

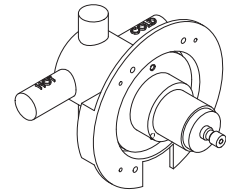

K-304-CS-NA K-304-US-NA
K-304-CX-NA K-304-UX-NA
K-304-PS-NA K-304-K-NA
K-304-PX-NA K-304-KS-NA

MOEN® Posi-Temp®

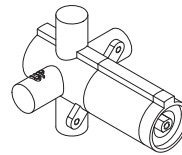

2510
2520
2570
2580
2590

SYMMONS® Temptrol®

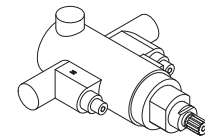

4000-BODY
4000-X-BODY
46-2-X-BODY

SEE REVERSE FOR ROUGH-IN DIMENSIONS

THIS SPACE FOR ARCHITECT/ENGINEER APPROVAL.

SPEAKMAN®

400 ANCHOR MILL ROAD | NEW CASTLE, DE 19720
P: 800-537-2107 | F: 800-977-2747
WWW.SPEAKMANCOMPANY.COM

REVISION DATE: DECEMBER 2014

Management Systems
Registered to ISO 9001

SPEAKMAN®

Neo™ Universal Trim CPT-1000-UNI

SPECIFICATION

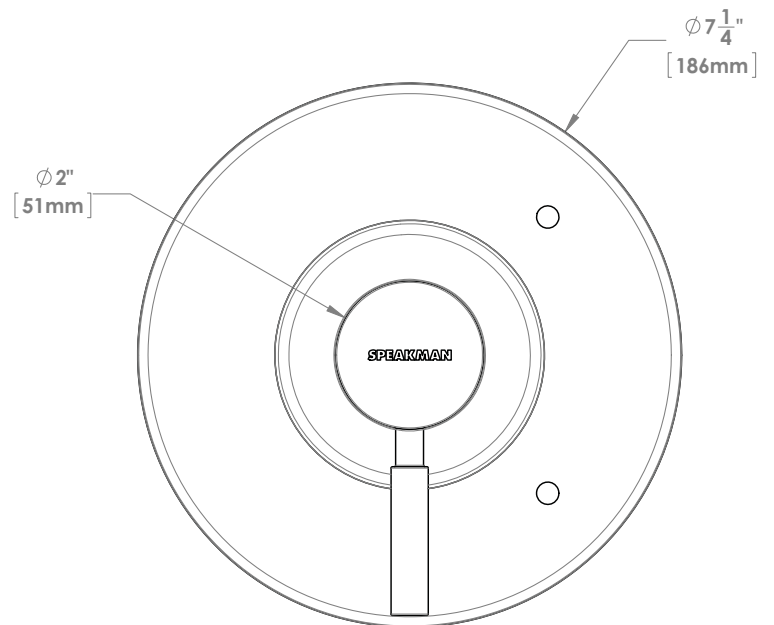
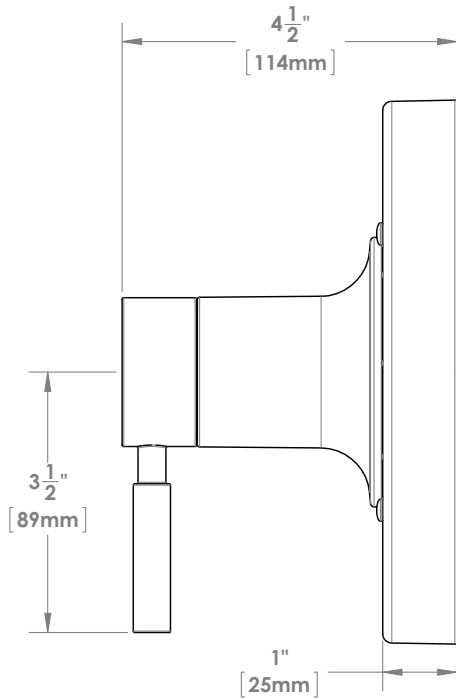

NOTE: 1. All dimensions are in inches (millimeters) unless otherwise specified and are subject to change without notice.

THIS SPACE FOR ARCHITECT/ENGINEER APPROVAL.

SPEAKMAN®

400 ANCHOR MILL ROAD | NEW CASTLE, DE 19720
P: 800-537-2107 | F: 800-977-2747
WWW.SPEAKMANCOMPANY.COM

Management Systems
Registered to ISO 9001

REVISION DATE: DECEMBER 2014