

## IMPORTANT SAFETY INSTRUCTIONS

- Be sure the electricity to the system you are working on is turned off; either the fuse removed or the circuit breaker set at off.
- Use of other manufacturers components will void warranty, listing and create a potential safety hazard.
- If you are unclear as to how to proceed, contact a qualified electrician.
- You don't need special tools to install this fixture.
- Be sure to follow the steps in the order given.
- To reduce the risk of fire, electric shock or personal injury, mount to outlet box or supporting system able to support the weight of the fixture.
- Read instructions carefully.
- Save these instructions.

## BEFORE YOU BEGIN

Carefully remove the fixture from the carton and check that all parts are included, as shown in figure 1 and 2. Be careful not to misplace any of the screws or parts which are needed to install this fixture.

**NOTE:** This glass is handcrafted, the slight imperfections in the glass add to the authenticity of the fixture.

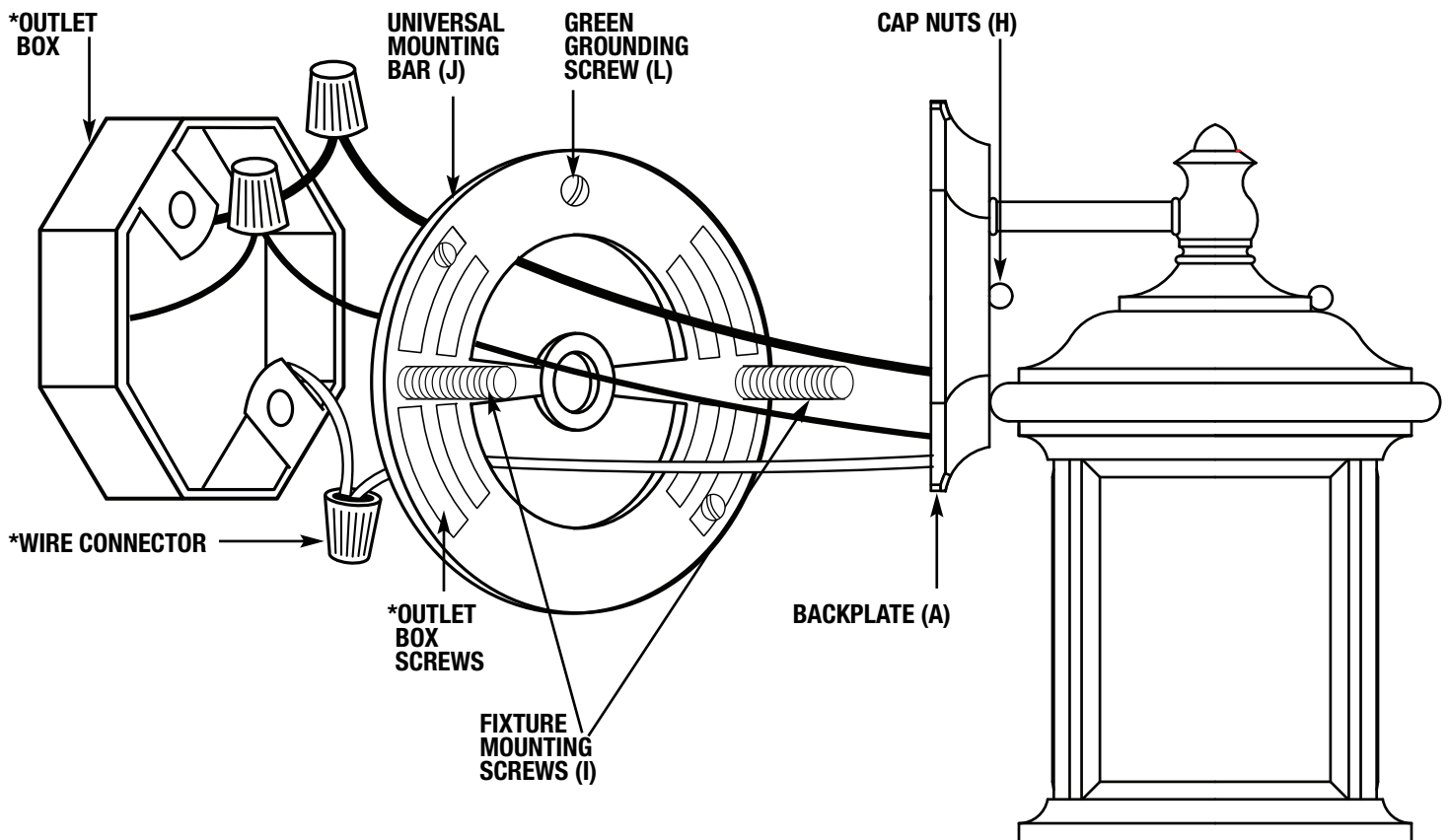

FIGURE 1

\*NOT INCLUDED

**IMPORTANT: DO NOT ATTACH FIXTURE DIRECTLY TO OUTLET BOX.**

**STEP 1:**

Insert fixture mounting screws (I) in threaded holes of universal mounting bar (J). Run screws all the way down to the heads.



**STEP 2:**

Place universal mounting bar (J) against outlet box (not supplied) and secure in place using outlet box screws (K) (not supplied). Be sure the mounting screws (I) are perfectly horizontal so fixture hangs straight.

**STEP 3:**

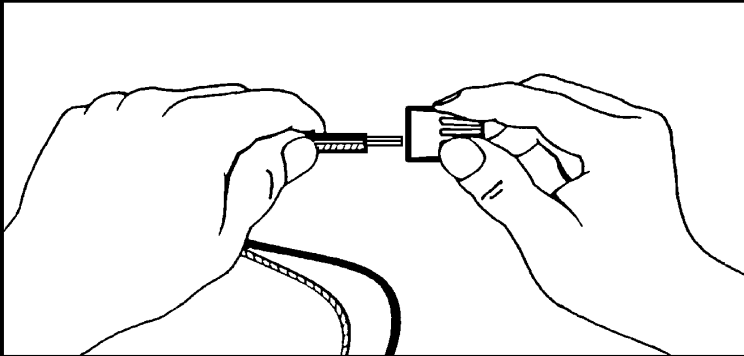
**A.** Take note of the color of the wire(s) on your fixture. Identify which group your fixture wire(s) falls into and connect the wires according to the directions below:

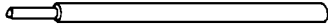
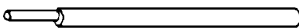

|  |   |
|--|---|
| <b>GROUP A:<br/>CONNECT TO BLACK HOUSE WIRE</b>                                    | <b>GROUP B:<br/>CONNECT TO WHITE HOUSE WIRE</b>                                     |
| <b>BLACK</b>   | <b>WHITE</b>  |
|  |  |
| <b>*PARALLEL WIRE (ROUND &amp; SMOOTH)</b>   | <b>*PARALLEL WIRE (SQUARE &amp; RIDGED)</b>   |
|  |  |

\*NOTE: When parallel wire is used, the tracer wire is square shaped or ridged, and the less tracer wire is round in shape or smooth. (Seen best when viewed from wire end.) To separate wires, grasp the ends of each wire and pull apart.

**B.** Take your fixture wire(s) from group A and place evenly against the black wire from the outlet box. **DO NOT** twist wires together before using wire connectors.

**C.** Fit a wire connector (not supplied) over the wires and thread the connector clockwise until you feel a firm resistance.

**D.** Gently try to remove the wires from the connector. If you can remove the wires, carefully re-do steps B and C, as above and check again for a firm connection.

**E.** Connect the fixture wire from group B to the white wire from the outlet box in the same manner.

**NOTE FOR FIXTURES THAT ARE SOLID BRASS:**

Your handcrafted, solid brass lighting fixture has been coated with a durable, baked on acrylic lacquer which gives maximum protection against the weather. In time, however, the brightness of the brass will tarnish giving way to an authentic old world brass finish. NOTE: To keep your solid polished brass fixture looking new for years to come, regularly apply a good quality non-abrasive car wax to all metal surfaces, giving the fixture an extra protective coating.

 MARK MEANS LAMP CONTAINS MERCURY. FOLLOW DISPOSAL LAWS. SEE WWW.LAMPRECYCLE.ORG

**STEP 4:**

**GROUNDING INSTRUCTIONS:** Connect the supply ground wire, fixture ground wire using UL approved wire nuts. Gently try to remove the wires from the connector. If you can remove the wires, carefully re-do the wiring connection.

**NEVER CONNECT GROUND WIRE TO BLACK OR WHITE POWER SUPPLY WIRES.**

**FINAL ASSEMBLY**

**Make sure no bare wires can be seen outside wire connectors.**

**NOTE: IF GLASS PANELS ARE NOT INSTALLED, PLEASE FOLLOW THIS STEP: PLACE BOTTOM EDGE OF GLASS INTO CHANNEL. BEND TABS OVER EDGE TO SECURE IN PLACE.**

**STEP 1:**

After wires are connected, tuck them carefully inside the outlet box. Position backplate (M) over mounting screws (I) and secure in place with cap nuts (H).

**STEP 2:**

Install lamp (A) by gently twisting into socket (B) (see figure 3).

**CLEANING**

To clean, wipe fixture with a soft cloth. Clean glass with a mild soap. Do not use abrasive materials such as scouring pads or powders, steel wool or abrasive paper.

**ORDERING PARTS**

Keep this sheet for future reference, and in case you need to order replacement parts. Parts for this fixture can be ordered from place of purchase. Be sure to use exact wording from illustration when ordering parts.

**WET LOCATION**

**NOTE: FOR FIXTURES LABELED FOR WET LOCATION AND USED OUTDOORS.**

**CAUTION:** To reduce the risk of electrical shock, provide a watertight seal between the fixture and the mounting surface by using a silicone or similar caulking.

**FIXTURES WITH A ONE PIECE LAMP / BALLAST COMBINATION**

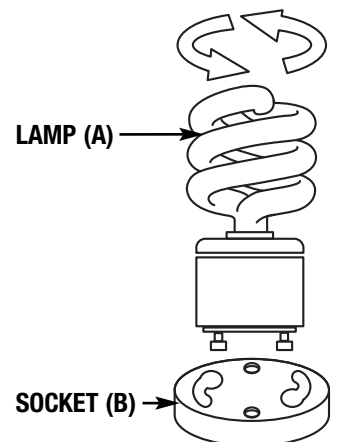

**FIGURE 3**