







6604  
Tub/Hand Shower System  
**Specification Submittal**



Model Numbers	Specification
<input type="checkbox"/> <b>6604</b> <i>Unity Tub/Hand Shower System</i>	<p>Tub/hand shower system powered by the Temptrol<sup>®</sup> Pressure Balancing valve. Features wall cradle, diverter tub spout, in-line vacuum breaker, 60" flexible metal hose, hand shower and standard 2.5 gpm (9.5 L/min) flow restrictor. Components made from metal and nonmetallic materials plated in standard polished chrome finish.</p> <div style="text-align: right;">   </div>
Modifications	Compliance
<ul style="list-style-type: none"> <li><input type="checkbox"/> <b>-1.5</b>  1.5 gpm (5.7 L/min) flow restrictor</li> <li><input type="checkbox"/> <b>-2.0</b>  2.0 gpm (7.6 L/min) flow restrictor</li> <li><input type="checkbox"/> <b>-SS</b> Slip spout on any tub/shower unit</li> <li><input type="checkbox"/> <b>-X</b> Integral service stops</li> <li><input type="checkbox"/> <b>-CHKS</b> Integral check stops</li> <li><input type="checkbox"/> <b>-IPS</b> 1/2" female IPS connections</li> <li><input type="checkbox"/> <b>-REV</b> Reverse coring for back to back installations</li> <li><input type="checkbox"/> <b>-LP</b> Loop handle</li> <li><input type="checkbox"/> <b>-QD</b> Quick disconnect on hand shower units</li> <li><input type="checkbox"/> <b>-R</b> White vinyl hose in place of metal hose</li> <li><input type="checkbox"/> <b>-OP</b> 13" oval plate</li> <li><input type="checkbox"/> <b>-72</b> 6' hose in place of 5' standard</li> <li><input type="checkbox"/> <b>-TRM</b> Trim only, valve not included</li> <li><input type="checkbox"/> <b>-STN</b> Satin Nickel finish</li> </ul>	<p>-ASME A112.18.1/CSA B125.1</p> <p>-WaterSense 1.5 gpm (5.7 L/min) 2.0 gpm (7.6 L/min)</p> <p>(Compliance pending)</p> <div style="text-align: right;">   </div>
	Warranty
<p><b>Note:</b> Append appropriate -suffix to model number.</p>	<p><b>Limited Lifetime</b> - to the original end purchaser in consumer/residential installations. <b>5 Years</b> - for industrial/commercial installations. Refer to <a href="http://www.symmons.com/warranty">www.symmons.com/warranty</a> for complete warranty information.</p>

## Dimensions

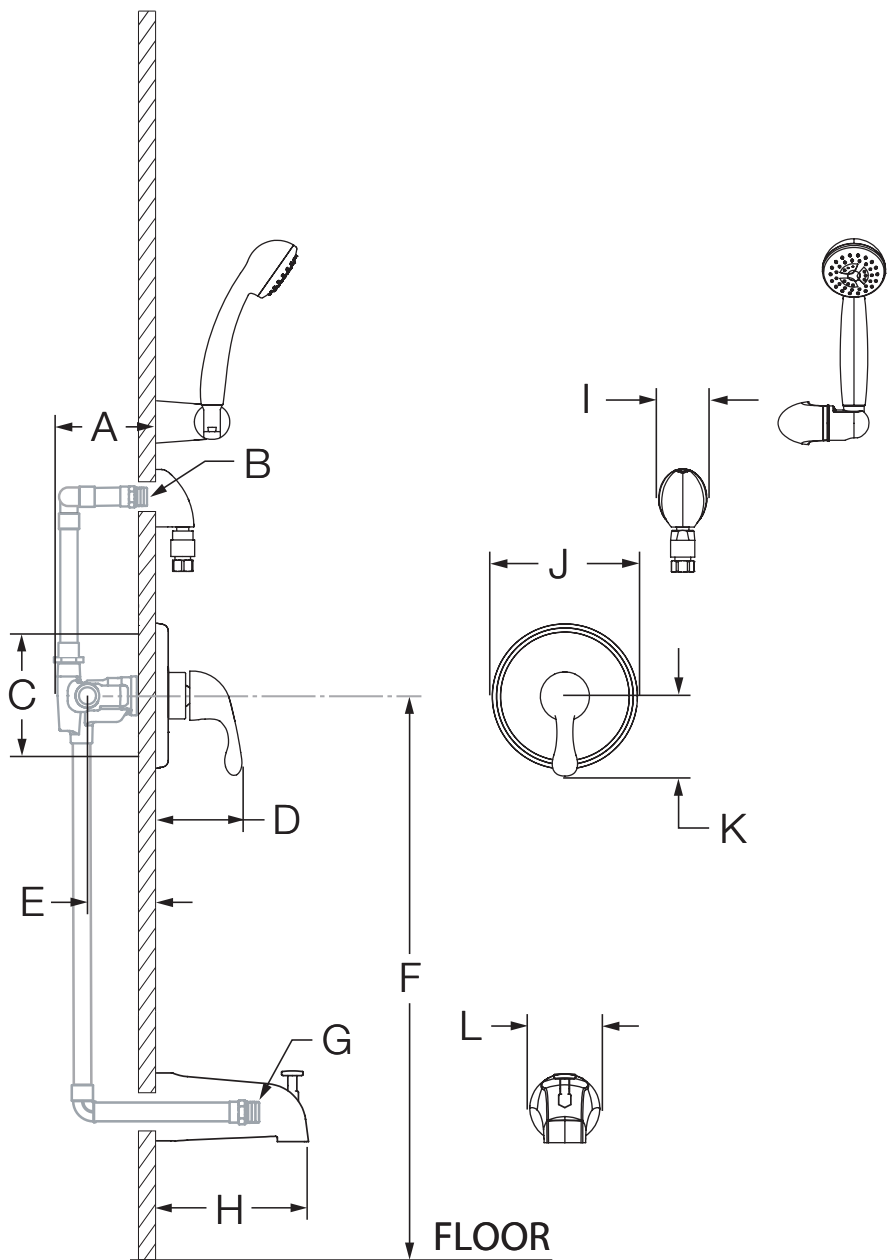

Measurements	
A	3 1/2", 89 mm
B	Male 1/2" NPT fitting must be recessed 1/4" from finished wall
C	Shower Valve Hole Size Min. Ø 3", 76 mm Max. Ø 4", 102 mm
D	3 3/4", 95 mm
E	Rough-in 2 3/8" ± 1/2", 60 mm ± 13 mm
F	Ref. 32", 813 mm
G	Male 1/2" NPT fitting must protrude 4" from finished wall
H	5 1/4", 133 mm
I	2 1/8", 54 mm
J	Ø 6 3/8", 162 mm
K	3 1/2", 89 mm
L	Ø 2 1/2", 64 mm

### Notes:

- 1) All dimensions measured from nominal rough-in (see E as reference).
- 2) Dimensions subject to change without notice.