

BILL OF MATERIAL (CURRENT LEVEL)

ITEM	PT/ASSY	DESCRIPTION	TYPE	QTY.
1	1-228	ACCESSORY MTG KIT	ASSEMBLY	1
2	1-125	HARDWARE KIT	ASSEMBLY	1
3	2-652	HANDLE ESCUTCHEON ASM	ASSEMBLY	1
4	11590	HANDLE BONNET	PART	1
5	7-652	END POST DOUBLE HOOK	ASSEMBLY	1

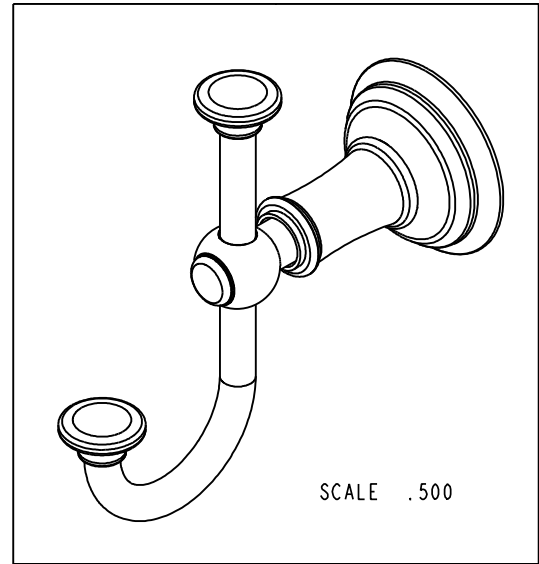

COPYRIGHT 2005 BRASSTECH, INC. THESE DRAWINGS AND THE DESIGNS DEPICTED HEREIN ARE THE PROPRIETARY PROPERTY OF BRASSTECH. ANY USE OR REPRODUCTION IS SUBJECT TO THE EXPRESS APPROVAL OF BRASSTECH. UNAUTHORIZED USE IS STRICTLY PROHIBITED. ALL RIGHTS RESERVED.

BRASSTECH INCORPORATED <small>2001 E. CARNEGIE AVE. SANTA ANA, CA 92705 (949) 417-5207</small>	<h2>DOUBLE ROBE HOOK</h2>	ASSY. NO.	34-13		-	-	-
		SCALE .500	REF. -	SHEET 1 OF 2	REV	REV DESC	DATE

SPECIFICATION DWG

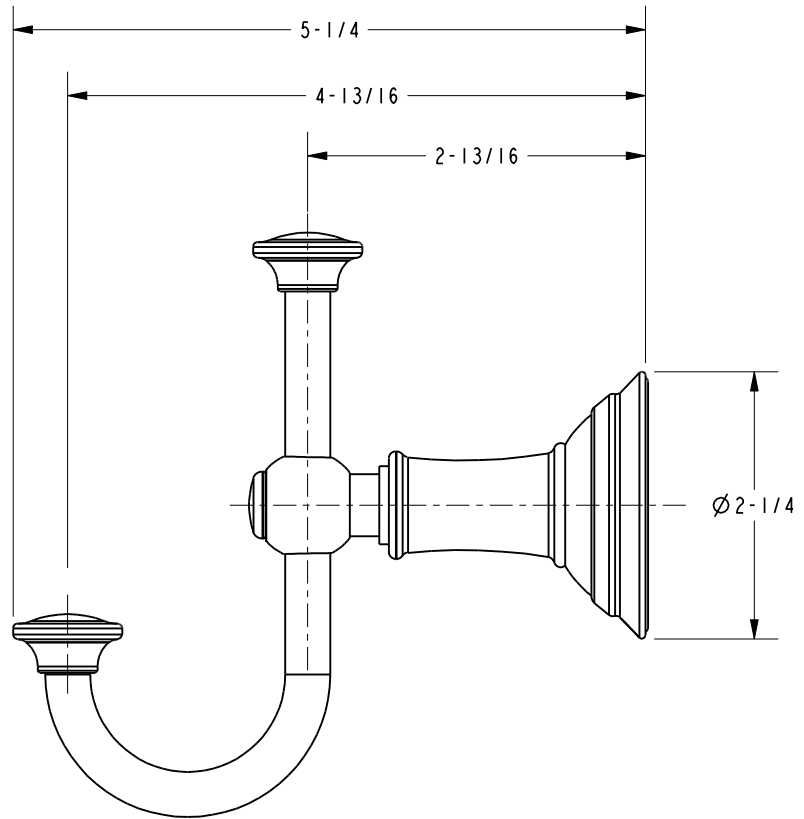
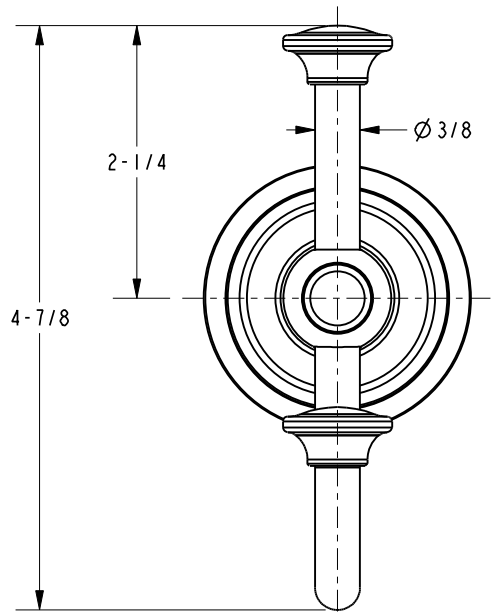

DIMENSIONS ARE IN INCHES AND AN APPROXIMATION OF A TYPICAL INSTALLATION

COPYRIGHT 2005 BRASSTECH, INC. THESE DRAWINGS AND THE DESIGNS DEPICTED HEREIN ARE THE PROPRIETARY PROPERTY OF BRASSTECH. ANY USE OR REPRODUCTION IS SUBJECT TO THE EXPRESS APPROVAL OF BRASSTECH. UNAUTHORIZED USE IS STRICTLY PROHIBITED. ALL RIGHTS RESERVED.

BRASSTECH		2001 E. CARNEGIE AVE. SANTA ANA, CA 92705 (949) 417-5207	
INCORPORATED			
DWG NO.	34-13	REF.	REV -
SCALE .625	REF. -	SHEET 2 OF 2	