

Family: Atlantis | Item No. 1649

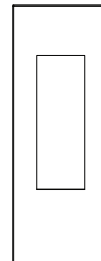

Drawing 1 - Fixture Mounting

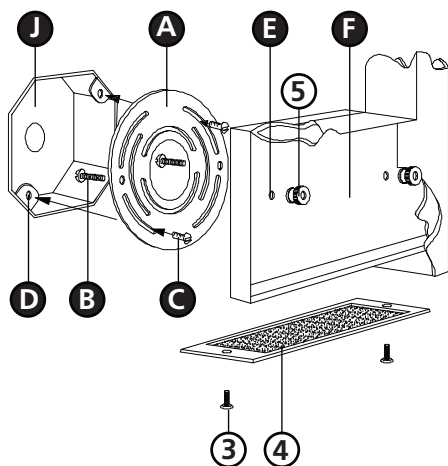

▼ start here

1

1. Find a clear area in which you can work.
2. Unpack fixture and glass from carton.
3. Carefully review instructions prior to assembly.

***** The construction of this fixture will be accomplished by first attaching the mounting strap to the junction box, making all necessary electrical connections, mounting the fixture to the wall, and then lamping the fixture.**

2

1. Prepare mounting strap (A) by threading the two 8-32 x 1 mounting screws (B) into the back of the mounting strap (A) - see **Drawing 1**.
 - Be sure the holes into which the screws are threaded match the spacing of holes (E) in the backplate (F).
2. Attach mounting strap (A) to junction box (J) by threading 2 screws (C) provided into holes (D) of junction box (J).
3. Un-thread the 2 screws (3) from the bottom lens cover (4) and remove lens cover (4).

SAFETY WARNING: READ WIRING AND GROUNDING INSTRUCTIONS (I.S. 18) AND ANY ADDITIONAL DIRECTIONS. TURN POWER SUPPLY OFF DURING INSTALLATION. IF NEW WIRING IS REQUIRED, CONSULT A QUALIFIED ELECTRICIAN OR LOCAL AUTHORITIES FOR CODE REQUIREMENTS.

3

Make electrical connections from supply wire to fixture lead wires. Refer to instruction sheet (I.S. 18) and follow all instructions to make all necessary wiring connections. Then refer back to this sheet to continue installation of this fixture.

4

1. To mount fixture, line up holes (E) in backplate (F) and slide fixture over both 8-32 x 1 screws (B) - see **Drawing 1**.
2. While holding fixture in place, thread the two 8-32 battery nuts (5) provided onto screws (B) and tighten with pliers.

5

1. Bottom of fixture can now be lamped accordingly.
2. Re-place bottom lens cover (4) and secure with the 2 screws (3) - see **Drawing 1**.
3. To lamp top of fixture. remove lens cover (4) by un-threading 2 screws (3).
4. Top of fixture can now be lamped accordingly.
5. Replace lens cover and secure with the 2 screws (3).

Note: Maximum wattage for the 1649 is GU-10, 20 watt MR-16

2.7.08

Drawing 1 - Flush Mount



Drawing 2 - Chain Hung



Drawing 3 - Post-Mount



SAFETY WARNING: READ WIRING AND GROUNDING INSTRUCTIONS (I.S. 18) AND ANY ADDITIONAL DIRECTIONS. TURN POWER SUPPLY OFF DURING INSTALLATION. IF NEW WIRING IS REQUIRED, CONSULT A QUALIFIED ELECTRICIAN OR LOCAL AUTHORITIES FOR CODE REQUIREMENTS.

wiring instructions

Indoor Fixtures

1. Connect positive supply wire **(A)** (typically black or the smooth, unmarked side of the two-conductor cord) to positive fixture lead **(B)** with appropriately sized twist on connector - see **Drawings 1 or 2**.
2. Connect negative supply wire **(C)** (typically white or the ribbed, marked side of the two-conductor cord) to negative fixture lead **(D)**.
3. Please refer to the **grounding instructions** below to complete all electrical connections.

Outdoor Fixtures

1. Connect positive supply wire **(A)** (typically black or the smooth unmarked side of the two-conductor cord) to positive fixture lead **(B)** with appropriately sized twist on connector - see **Drawings 2 or 3**.
2. Connect negative supply wire **(C)** (typically white or the ribbed, marked side of the two-conductor cord) to negative fixture lead **(D)**.
3. Cover open end of connectors with silicone sealant to form a watertight seal.
 - If installing a wall mount fixture, use caulk to seal gaps between the fixture mounting plate (backplate) and the wall. This will help prevent water from entering the outlet box. If the wall surface is lap siding, use caulk and a fixture mounting platform specially.
4. Please refer to the **grounding instructions** below to complete all electrical connections.

grounding instructions

Flush Mount Fixtures

For positive grounding in a 3-wire electrical system, fasten the fixture ground wire **(E)** (typically copper or green plastic coated) to the fixture mounting strap **(1)** with the ground screw **(2)** - see **Drawing 1**.

Note: On straps for screw supported fixtures, first install the two mounting screws in strap. Any remaining tapped hole may be used for the ground screw.

Chain Hung Fixtures

Loop fixture ground wire **(E)** (typically copper or green plastic coated) under the head of the ground screw **(2)** on fixture mounting strap **(1)** and connect to the loose end of the fixture ground wire directly to the ground wire of the building system with appropriately sized twist-on connectors - see **Drawing 2**.

Post-Mount Fixtures

Connect fixture ground wire **(E)** (typically copper or green plastic coated) to power supply ground with appropriately sized twist-on connector inside post. Cover open end of connector with silicone sealant to form a watertight seal - see **Drawing 3**.

 **start here**

1. After securing fixture to the wall it is recommended that the gap between the wall and the fixture backplate be sealed with any good quality waterproof caulk or silicone sealant, on the top and sides leaving the bottom open as a weep hole.
(NOT INCLUDED) see Drawing 1.



Drawing 1