



MANHATTAN
COMFORT

888-230-2225

help@manhattancomfort.com

319 Ridge Rd. Dayton, NJ 08810, New Jersey - United States



Rockefeller

2.0 Bookcase

Included in the package

Part	Description	Qty	Box
01	Base	01	01
02	Top	01	01
03	Lateral	02	01
04	Shelf	04	01
05	Rear Panel	01	01
12	Feet	04	01

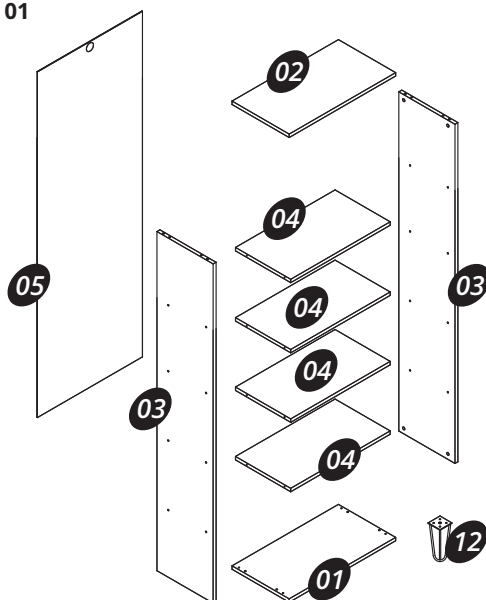

Hardware



A = 16x

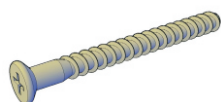

B = 16x

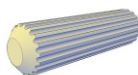

C = 08x

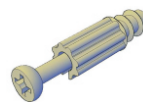

D = 08x



E = 08x



F = 02x



G = 42x

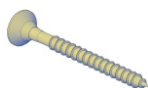

H = 01x



I = 01x



J = 01x



K = 08x

Tools needed (not included)

1x

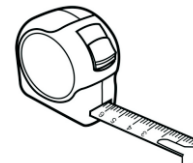
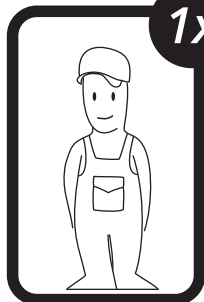

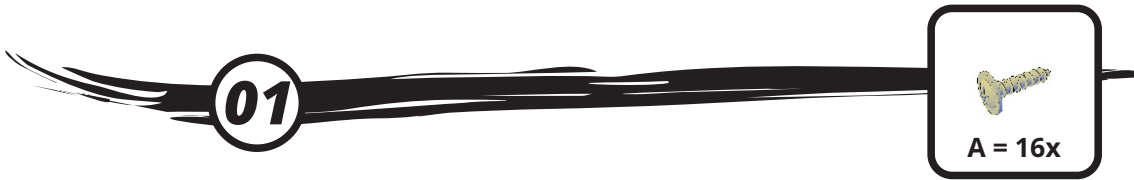
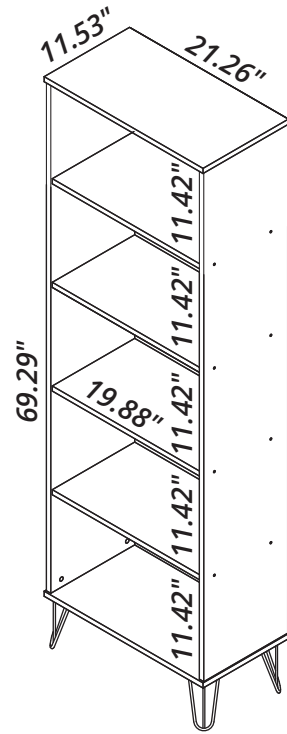
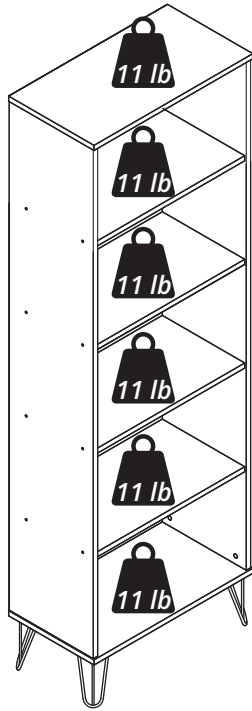

Connect the part (12) onto the part (01) with the hardware (A).

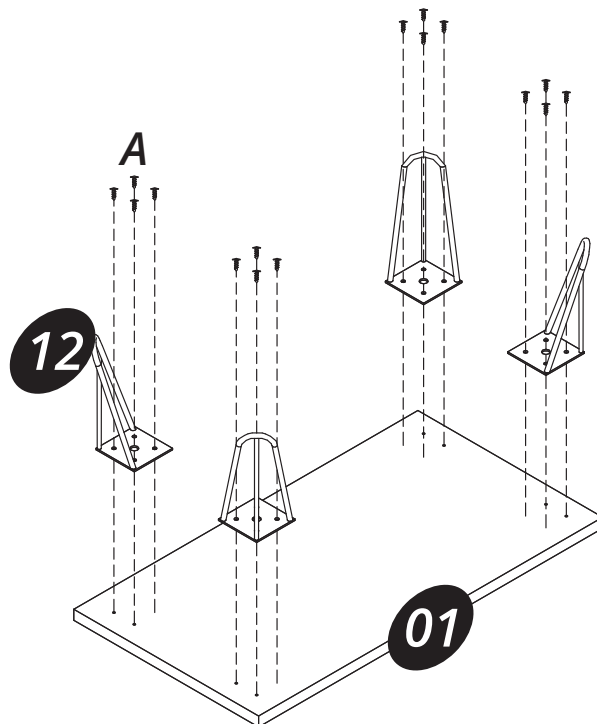

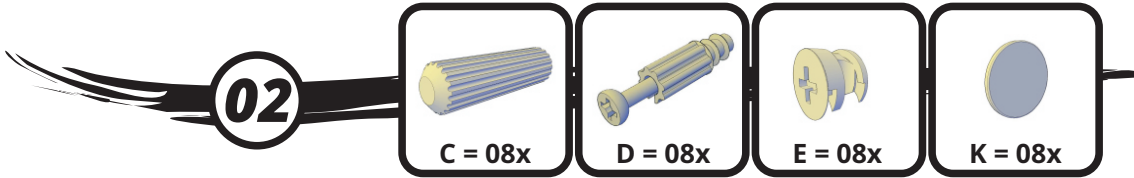

Connect the parts (03) onto the parts (01 and 02) using the hardware (C + D + E). Apply the hardware (K) on the hardware (E).

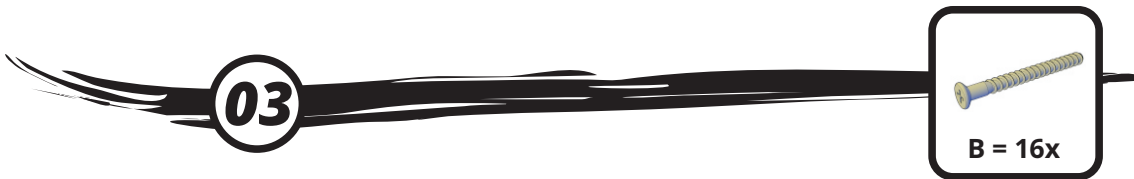
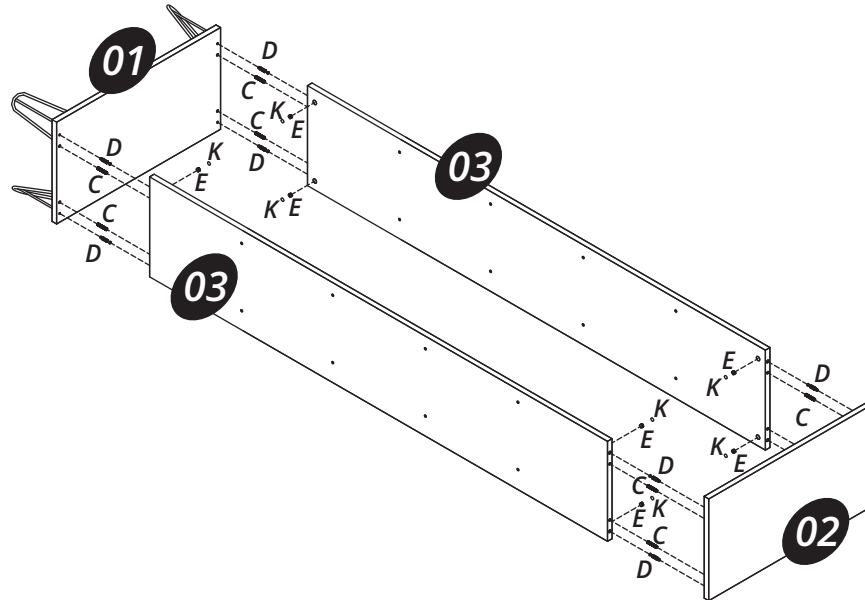

Connect the parts (04) onto the parts (03) with the hardware (B).

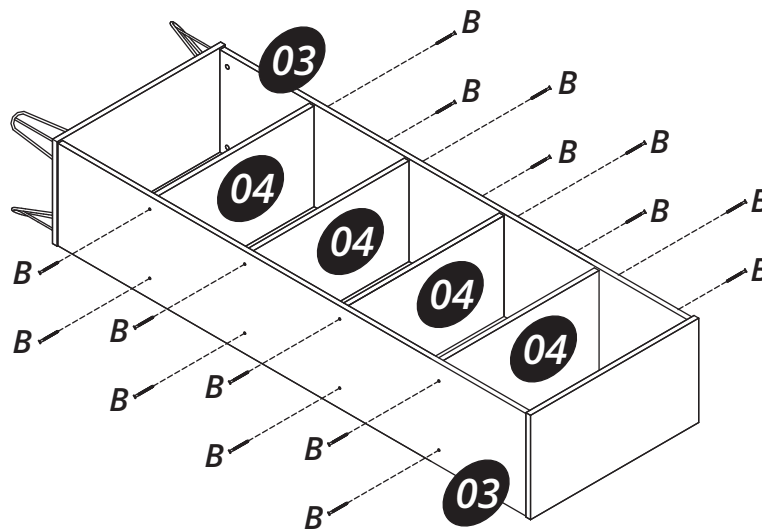

04



G = 42x

Connect the part (05) using the hardware (G).

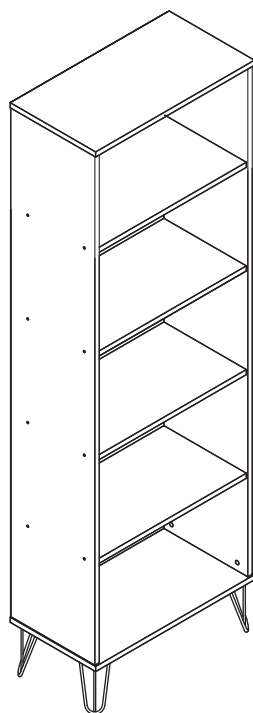
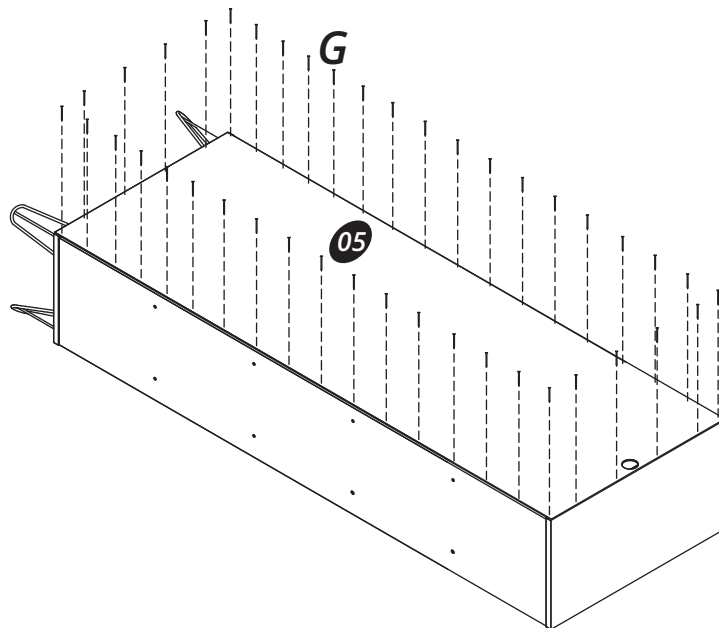

Attention! Tipover System

F = 02x

H = 01x

I = 01x

J = 01x

wall

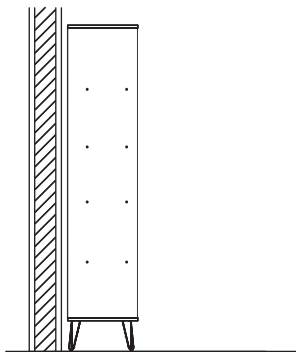

First, approach as close as possible to the wall

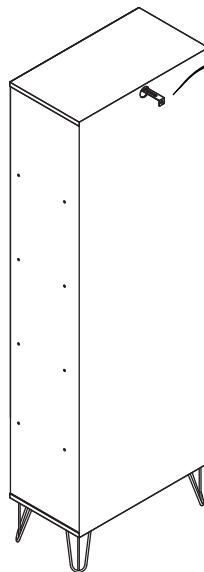

Then, pass the hardware (J) through the hole of the part (05) as shown in the figure above. You will need a pencil to mark where you should drill the wall with a 3/8" drill bit to put in the hardware (I).

*press the hardware wings (I) to put in the hole that you drilled in the wall.

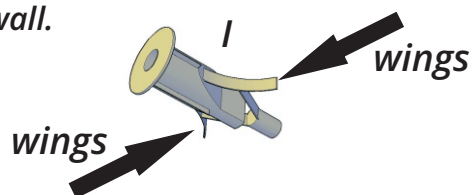

Hardware (I), plugged in the wall.

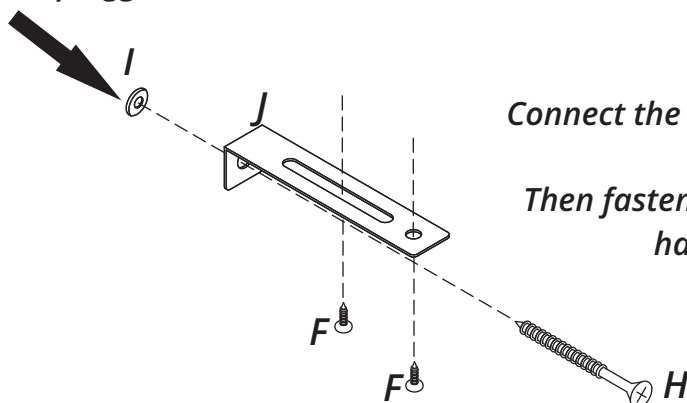

Connect the hardware (J) onto the wall with the hardware (H). Then fasten with the hardware (F) the hardware (J) on the part (02)